



eClear[®]

on Oxygen

Healthy Water. Healthy Earth. Healthy You.

USER MANUAL

POOLS • DRINKING WATER • PONDS

MK7/CF1-75 • MK7/CF1-75UV • Pools up to 75m³
MK7/CF1-150 • MK7/CF1/150UV • Pools up to 150m³
MK7/CF1-250 • MK7/CF1-250UV • Pools up to 250m³
MK7/CF1-500 • MK7/CF1-500UV • Pools up to 500m³
MK7/CF1-750 • MK7/CF1-750UV • Pools up to 750m³
MK7/CF1-1000 • MK7/CF1-1000UV • Pools up to 1000m³
On Request • Pools up to 10 000m³

CONTENTS

Section 1: General Information	3
1.1. Safety	3
1.2. Product Overview	3
1.3. Model Description	3
Section 2: Specifications.....	3
2.1. Electronic Box.....	3
2.2. Electrode Chamber (inline and assembly versions)	3
2.3. Ultraviolet Chamber	3
Section 3: Installation	4
3.1 Unpacking - <i>What's in the box</i>	4
3.2 Switches Orientation	5-6
3.3 Connections	6
3.3.1. Electrodes connections.....	6
3.3.2. Large Box and assembly.....	7
3.3.3. UV connections.....	7
3.3.4. e-Clear water purification systems technical specifications	8
3.3.4.1. General specifications	8
3.3.4.2. Specifications per model.....	9-11
Section 4: System Start-up.....	11
4.1 Controls Orientation	11
4.2 Controls Description	11
4.3 Large Box Control Orientation.....	12
4.4 Water Preparation - IMPORTANT	12
4.4.1. Calcium	12
4.4.2. pH	12
4.4.3. Copper residual	12-13
4.4.4. Filtration	13-14
Section 5: Standard Operation.....	14
5.1 Oxidation (black electrodes, white cable, 2 pin)	14
5.2 Ionization (pink electrodes, black cable, 3 pin)	14
5.3 Ultraviolet	14
Section 6: Maintenance	14
6.1 General maintenance	14
6.2 Electrode cleaning	14-15
6.3 Electrode replacement.....	15
6.4 UV lamp replacement	15
6.5 Repair/ Spares service.....	16
Section 7: Certification and Limited Warranty	17
7.1 Patent.....	17
7.2 Limited Warranty	17
Section 8: Installation and Maintenance guide for eClear pools	18
8.1. Installation Guide.....	19
8.1.1. Physical Installation	20
8.1.2. Water Balancing	21

8.1.3.	eClear Pump and Filter Guidelines.....	22
8.1.4.	Technical Installation Guidelines for eClear Water Sanitizers	23-36
8.2.	Maintenance Guide	37
8.2.1.	Weekly Maintenance	38
8.2.2.	Annual Maintenance.....	38
8.2.3.	Water parameters.....	38
8.2.4.	Do's and Don'ts	39-40
8.2.5.	Common issues	41
8.2.6.	What can I add to my e-Clear pool?.....	41
Section 9: Problem solving guide.....		42
9.1	Problems with pool.....	43
A.	Water	43-44
B.	Walls	45-46
C.	Other.....	46
D.	Chemicals.....	47
Section 10: Spare Parts		48
10.1.	Spare parts.....	49
10.2.	Oxygenating, Ionization, and UV	50
Section 11: Drinking water systems		51
11.1.	Can you trust e-Clear?	52
11.2.	Eco-Fusion™ One-Tap Drinking Water System	54
11.2.1.	10" Big Blue Filter housing	54-55
11.2.2.	Melt blown 5 Micron pre-filter	55
11.2.3.	10" Big Blue Carbon Block Filters.....	55-56
11.2.4.	UV T5 16W High output UVC with quartz sleeve.....	56
11.3.	Eco-fusion whole house drinking water systems - Images System Components.....	58
11.3.1.	Eco-fusion drinking water systems – Technical specifications	59
11.3.2.	System Components.....	59
11.3.2.1.	20" Big Blue high flow filter housing.....	59-60
11.3.2.2.	Melt blown 5 Micron pre-filter	60
11.3.2.3.	20" Big Blue carbon block filters.....	61
11.3.3.	KDF Filters	62-63
11.3.3.1.	KDF 55.....	64
11.3.3.2.	KDF 85.....	64
11.3.4.	Siliphos filter	65
11.3.5.	55watt UVC high spectrotherm lamp	66
11.3.6.	e-Clear high output oxygen & copper ionization chambers – Science explanation.....	67
11.4.	e-Clear Eco-Fussion™ rainwater harvesting kit	69
11.4.1.	Rainwater Harvesting Averages for South Africa	70
11.4.2.	Specifications for Rainwater Harvesting kit	70
11.4.3.	10 000L Storage tank.....	70
11.4.4.	Davey 600KPA 90L/M Pump	70
11.4.5.	Davey Rainbank/ Torrium sensor valve	70
11.4.6.	3 Bag glass media filter	70
11.4.7.	0.75kw Pool pump	70
11.4.8.	Additional 5 000L storage tank	70
11.4.9.	Additional Davey 0.75kw submersible pump	71
11.4.10.	e-Clear high output oxygen & copper ionization chamber	71

SECTION 1: GENERAL INFORMATION

1.1 Safety

Please read this entire manual before unpacking, setting up or operating this equipment. Pay attention to all danger and caution statements. Failure to do so could result in serious injury to the operator or damage to the equipment. To ensure that the protection provided by this equipment is not impaired, do not install this equipment in any manner other than that specified in this manual.

1.2 Product Overview

The e-clear 100% Chlorine free New Generation 7 series- provides multiple forms of toxic free oxygen which splits into 4 powerful oxidisers (O₁)- (O₂)- (OH)- (H₂O₂).

These chemically free oxidisers are produced from and delivered directly into, the water stream, in grams per minute via Electronic Oxidation. This, combined with ultraviolet (optional) and ionization, provides the most advanced, most efficient, toxic free purification technology available for cleaning swimming pool water. Ensuring 100% chlorine free, bacteria free, algae free, and salt free, crystal clear water.

1.3 Model Description

MK7/CF1-75 • MK7/CF1-75UV • Pools up to 75m³
MK7/CF1-150 • MK7/CF1/150UV • Pools up to 150m³
MK7/CF1-250 • MK7/CF1-250UV • Pools up to 250m³
MK7/CF1-500 • MK7/CF1-500UV • Pools up to 500m³
MK7/CF1-750 • MK7/CF1-750UV • Pools up to 750m³
MK7/CF1-1000 • MK7/CF1-1000UV • Pools up to 1000m³
On Request • Pools up to 10 000m³

SECTION 2: SPECIFICATIONS

2.1 Electronic Box

Enclosure: IP67, PVC, splash proof.

Power (external): 230v AC, 50/60Hz input 4-12v DC output
- 230v output to UV ballast (if in separate box)

Operating temperature: 0 - 60 °C

Weight: 1.0 kg

2.2 Electrode Chamber (inline and assembly versions)

Enclosure: Poly vinyl Chloride (PVC)

Oxygen electrode: Titanium Composite

Ionization Electrode: Copper composite

Connecting bolts: 316 food grade stainless steel

Operating temperature: 0-50 °C

Weight: 1.5kg - 15kg

2.3 Ultraviolet Chamber

Enclosure: 316 food grade stainless steel

Other parts: PVC

Lamp: 55 W UVC high output ultraviolet germicidal fluorescent lamp.

SECTION 3: INSTALLATION

3.1 Unpacking - *What's in the box*



STANDARD DIGITAL

OR



PREMIUM TOUCHSCREEN

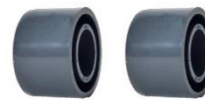

2 X REDUCING BUSHES
90-63MM OR 63-50MM



63MM OR 90MM ELECTRODE CHAMBER



COPPER TEST KIT

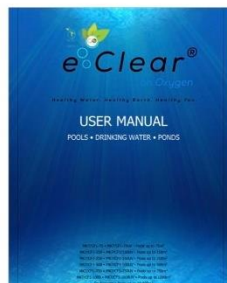

USER MANUAL



INSTALLATION
GUIDE

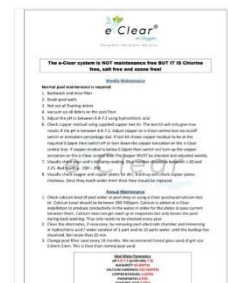

MAINTENANCE
SCHEDULE

DANGER: AC mains outlets in wet or potentially wet locations must always be provided with a ground fault circuit interrupting circuit breaker (GFCI/GFI).

3.2 Switches Orientation

Mains ON/OFF - bottom of box



Side of box:

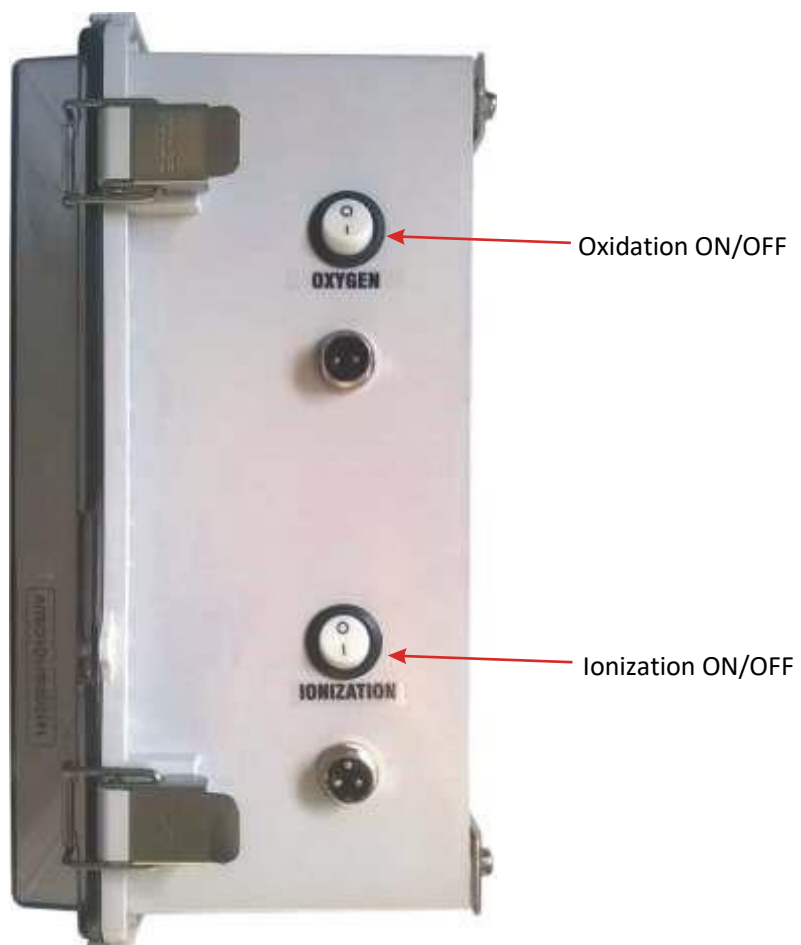

UV ON/OFF



3.3 Connections

3.3.1 Electrodes connections



3.3.2 Large Box and Assembly



3.3.3 UV Connections

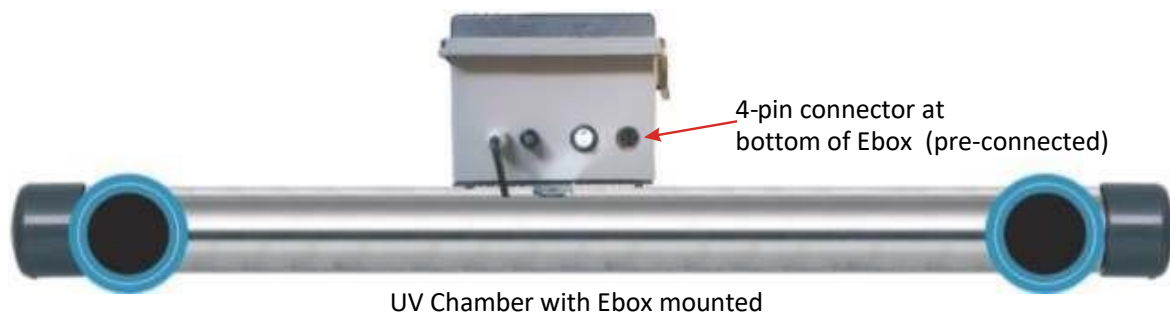

3.3.4. eClear Water Purification Systems Technical Specifications

3.3.4.1. GENERAL SPECIFICATIONS

ULTRAVIOLET CHAMBER

Extended chamber for longer contact time to water. Removes 99.9% of all waterborne parasites and diseases-including the deactivation of cryptosporidium. Special long life high Spekthrotherm germicidal UV lamps. 10 000hrs.

ELECTRONIC MANAGEMENT UNIT

Microprocessor technology with integrated digital display. Auto boost for increased current dosing of oxygen/ionization electrodes. Electronic UV lamp ignition and "lamp failure indicator. Digital display indicators for dosing output of oxygen/ionization. Fully programmable SECAM system.

90mm Oxygen Assembly

Length: 220mm

Width: 45mm

Depth: 85mm

Weight: 600g

Lug size: M6

Material: Base material – Titanium

Coating material – Proprietary coating

Patented Technology 2003/02934

Surface area: $138600\text{mm}^2=1386\text{cm}^2$
 0.139m^2

Current draw: 2.2 Amps - 9 Volts

Chemical Production:

Hydroxyl ions – OH

Atomic Oxygen – O₁

Oxygen - O₂

Hydrogen peroxide – H₂O₂

90mm Copper plate

Length: 120mmX75mmX40mm

Weight: 850g

Lug size: M6

Material: Cu

Characteristics:

Biostatic

Antimicrobial

Function: Release of copper ions

Lifespan: 1-3 years

63mm Oxygen Assembly

Length: 200mm

Width: 42mm

Depth: 54mm

Weight: 300g

Lug size: M6

Material: Base material – Titanium

Coating material – Proprietary coating

Patented Technology 2003/02934

Surface area: $55\ 500\text{mm}^2=555\text{cm}^2$
 0.0559m^2

Current draw: 2.2 Amps - 9 Volts

Chemical Production:

Hydroxyl ions – OH

Atomic Oxygen – O₁

Oxygen - O₂

Hydrogen peroxide - H₂O₂

63mm Copper Plate

Length: 100mmX46mmX25mm

Weight: 450g

Lug size: M6

Material: Cu

Characteristics:

Biostatic

Antimicrobial

Function: Release of copper ions

Lifespan: 1-3 years

3.3.4.2. SPECIFICATIONS PER MODEL

MK – 75

Size Inline chamber: 63mm straight (470mm x 100mm) Electronic box: 300mm x 180mm x 150mm	Electrical 5v •40w•2.5A 12hrs=0.3kWh/day
Weight Inline chamber: 2.25kg Electronic box: 2.7 kg	Flow rate: 90ℓ/ min 0.5 m/sec

MK – 75UV

Size Inline chamber: 63mm straight (470mm x 100mm) UV chamber & E-box: 360mm x 980mm	Electrical 5v •40w•2.5A 12hrs=0.3kWh/day
Weight Inline chamber: 2.25kg UV Chamber & E-box: 7.3 kg	Flow rate: 90ℓ/ min 0.5 m/sec

MK – 150

Size Inline chamber: 90mm straight (470mm x 130mm) Electronic box: 300mm x 180mm x 150mm	Electrical 5v •40w•2.5A 12hrs=0.3kWh/day
Weight Inline chamber:4.5 kg Electronic box: 2.7 kg	Flow rate: 300ℓ/min 1 m/sec

MK – 150UV

Size Inline chamber: 90mm straight (470mm x 130mm) UV chamber & E-box: 360mm x 980mm	Electrical 230v•150w•2.5A 12hrs=1.5kWh/day
Weight Inline chamber: 4.5kg UV Chamber & E-box: 16kg	Flow rate: 90ℓ/min 0.5 m/sec

MK – 250

Size Inline chambers 4 x 470mm x 130mm E-box:400mm x 300mm x 160mm	Electrical 5v•160w•10A 12hrs=1.2kWh/day
Weight Inline chambers: 13.5kg E-box: 6kg	Flow rate: 1800ℓ/ min 2 m/sec

MK – 250UV**Size**

Inline chamber: 4 x 470mm x 130mm
UV chamber and E-box:
500mm x 1020mm x 400mm

Weight

Inline chambers: 13.5kg
UV chamber and E-box: 23kg

Electrical

230v•380w•10A
12hrs=4kWh/day

Flow rate:

1800ℓ/ min
2 m/sec

MK – 500**Size**

Inline chambers: 8 x 470mm x 130mm
E-box: 2 x 400mm x 300mm x 160mm

Weight

Inline chambers: 27kg
E-box: 2 x 6kg

Electrical

5v•320w•20A
12hrs=2.5kWh/day

Flow rate:

3600ℓ/min
4 m/sec

MK – 500UV**Size**

Inline chamber: 8 x 470mm x 130mm
2 x UV chamber and 2 x E-box:
2 x 1020mm x 500mm x 400mm

Weight

Inline chambers: 27kg
2 x UV chamber and 2 x E-box: 2 x 23kg

Electrical

230v•720w•20A
12hrs=8kWh/day
Chambers: 8x470mm x130m

Flow rate:

3600ℓ/min
4 m/sec

MK – 750**Size**

Inline chambers: 12 x 470mm x 130mm

Weight

Inline chambers: 40.5kg
E-box: 3x6kg

Electrical

5v•480w•30A
12hrs=3.6kWh/day

Flow rate:

5200ℓ/min
6 m/sec

MK – 750UV**Size**

Inline chamber: 12 x 470mm x 130mm
3 x UV chamber and 3x E-box:
3 x 1020mm x 500mm x 400mm

Weight

Inline chambers: 40.5kg
3 x UV chamber & 3xE-Box: 3 x 23kg

Electrical

230v•1140w•30A
12hrs=12kWh/day

Flow rate:

5200ℓ/min
6 m/sec

MK – 1000

Size

Inline chambers: 16 x 470mm x 130mm
E-box: 4 x 400mm x 300mm x 160mm

Weight

Inline chambers: 54kg
E-box: 4 x 6kg

Electrical

5v•640w•40A
12hrs=5kWh/day

Flow rate:

7200l/min
8 m/sec

MK – 1000UV

Size

Inline chamber: 16 x 470mm x 130mm
4 x UV chamber and 4 x E-box:
4 x 500mm x 1020mm x 400mm

Weight

Inline chambers: 54kg
4 x UV chambers and 4 x E-box: 4x23kg

Electrical

230v•1450w•40A
12hrs=16kWh/day

Flow rate:

7200l/min
8 m/sec

SECTION 4: SYSTEM START-UP

4.1 Controls Orientation

1. Oxygen Power Indicator
2. Ionization Power Indicator
3. UV on/off Switch
4. Oxygen Dosing Dial
5. Ionic Dosing Dial
6. Ionic Program Dial
7. Quick Setup Instructions
8. Ionic Dosing Indicator
9. Oxygen Dosing Indicator



4.2 Controls Description

1. Oxygen and ionization dosing meter
2. High/ low output switch
3. Increase/ decrease dosing dial
4. Ionization output indicator
5. Oxygen output indicator
6. Polarity indicator
7. Main power on/off switch
8. Electrode power on/off
9. UV on/off
10. White cable to oxygen plates and on/off switch
11. Black cable to copper plates and on/off switch

4.3 Large Box Control Orientation



4.4 Water Preparation - **IMPORTANT**

4.4.1 Calcium

- A calcium hardness of at least *250ppm* in your pool water is essential when operating the e-clear system. This is necessary to maintain the *conductivity* of the water, thereby ensuring operational efficiency.
- The procedure of raising the calcium hardness in the pool water should be carried out by the installer or by a qualified pool technician making use of the prescribed test equipment.
CAUTION-the e-clear system will not operate properly without this pre-requisite calcium hardness.

4.4.2 pH

- The correct operating pH in the pool water, for the e-clear system to operate efficiently, is in the range of *6.8- 7.2*. If the pool water's pH is allowed to rise above 7.3 for longer than 48 hours, the water may turn green.
- A pH range of 6.8- 7.2 must be maintained if the pool water is to clean and clear. pH may need to be adjusted as often as, every second day, or as little as once a week. This is dependent on individual swimming pool conditions (e.g. Amount of sun, leaves or people entering the pool)
- E-clear accepts no responsibility for staining due to irregular maintenance of pool PH levels.

4.4.3 Copper Residual

- A copper residual of 0.5ppm in the pool water is necessary to maintain Bacteria/algae free conditions and maximum performance of the oxidation process.
- Upon initial operation of the e-clear system, the copper residual will take a period of time to reach 0.5ppm. In the interim, additional help is required to ensure clean and clear pool water during this

'set-up' period it is necessary to *shock treat* the water with, either, chlorine or active oxygen (until the copper residual reaches 0.5ppm) This initial set-up period may last a couple of weeks, depending on individual conditions.

- Once the copper residual is 0.5ppm, it is no longer necessary to shock treat the water, the pool will run only on the e-clear system- 100% chlorine free.
- In order to achieve a copper residual of 0.5ppm quicker, it may be necessary to run the pool's circulation pump *24 hours*, along with the e-clear system. During this initial setting up period it will be necessary to test the copper often, until 0.5ppm is achieved.
- Once this residual is achieved the ionization may be switched off at the side of the box. Only switch on the ionization again, when the copper residual drops below 0.5ppm. Test the copper *weekly* to note the residual.

To test copper:

- Switch off e-clear unit power.
- Backwash and rinse filter.
- *Test pH* if not between 6.8 and 7.2, readjust pH manually by adding pool acid (see instructions on can label). Once the pH is in the range of *6.8-7.2*, the copper may be tested.
- CAUTION- A false copper reading will occur if the pH is out of the range of 6.8-7.2
- CAUTION- during initial start-up it is necessary to circulate the pool water 24 hours a day. Thereafter adjust the pool's timer to run according to times detailed on face of e-clear electronic box. See below- filtration times.
- Switch e-clear unit on
- If copper residual is 0.5ppm or higher, switch off ionization (on side of electronic box). If copper is below 0.5ppm, switch on copper until 0.5ppm is achieved.
- NOTE- Oxidation always remains on.
- CAUTION- During winter months it may be necessary to ionize less.

4.4.4 Filtration

- Pool Volume
40 - 50m³ (40 000L- 50 000L)- 6 hours
55-75m³- 8 hours
80-100m³- 10 hours (12 in very hot weather)
105-125m³- 12 hours (15 in very hot weather)
130-150m³- 15 hours (18 in very hot weather)
- Above indicates the length of time necessary to operate the e-clear system. (oxidation always on when e-clear unit on and ionization as necessary- see Above)
- If the swimming pool is heated and is circulating 24 hours a day, it is necessary to install a separate timer controlling the eClear system, in order to operate the e-clear system only, for the periods shown above

CAUTION- too much oxidation will cause the pool water to appear hazy. Too much copper may stain pool walls. These must be maintained correctly.

Hazy water

- Glass media filter may be inadequate- a minimum of between 160kg and 300kg of high quality filter glass media is required for the e-clear system to operate effectively.
- A deep filter bed of between 800mm and 1000mm of filter glass media is ideal. If filter is adequate and copper residual is 0.5ppm and water is hazy, then a filter flocculant or gel bloc may be necessary (follow instructions for use on package)

- An algaecide may also be added (see package instructions). If hazy water persists, the flow rate through the filter may be too weak.
- A turnover of the entire pool's volume every 4 hours is necessary. This may be achieved through use of a stronger pool pump and bigger diameter circulation pipes.

SECTION 5:STANDARD OPERATION

5.1 Oxidation (black electrodes, white cable, 2 pin)

When the e-clear electronic box is powered, the oxygen plates should always be powered, i.e. They need never be switched off independently of the mains power. The electronic box must only be powered when the pool water is circulating see section 4.4.4.

5.2 Ionization (pink electrodes, black cable, 3 pin)

During standard operation, it is necessary to carefully gauge usage of swimming pool i.e. Body load, amount of sunshine pool water receives and amount of debris falling into water. These factors will determine the length of time the ionization plates are to be on. This is done by regularly testing the copper and maintaining the 0.5ppm residual by manually switching the copper on or off at the side of the electronic box. Eventually an equilibrium will be reached. For example, it might be necessary to run the ionization every 4 days out of 7 to maintain the copper residual at 0.5ppm under current conditions.

5.3 Ultraviolet

Lamp life is 10 000? Hours. UV runs when electronic box is powered.

Check UV lamp indicator on face of electronic box for operation. Replace after 10 000 hours of operation.

SECTION 6:MAINTENANCE

6.1 General maintenance

It is extremely important to maintain a pH in the range of 6.8-7.2. This allows for most effective operation of eClear's natural fresh water oxidation process.

It is extremely important to maintain a copper residual of 0.5ppm. This will ensure the cleanest, safest pool water.

It is extremely important to maintain clean filter glass media for maximum filtration of all solid matter. This is done by regularly backwashing and rinsing the filter and by changing or rejuvenating the filter glass media annually.

Calcium hardness may need to be checked annually, especially in pool's that are topped up with new water regularly. Ensure that this is carried out by a professional.

6.2 Electrode cleaning

Both the oxygen and copper plates may, from time to time become caked with dirt. This will impede proper performance of the e-clear system. It is therefore necessary to clean the plates or to have them cleaned by a certified e-clear technician.

Method for cleaning plates:

- Switch off the pool pump and e-clear unit
- Undo nuts at plates to remove electrode cables

- Unscrew unions at each end of the copper chamber and at each end of the oxygen chamber.
- Dilute one part pool acid (hydrochloric acid) to five parts water, in a bucket. About a 20cm deep solution.
- Immerse each chamber in the acid solution for about 5 minutes or until build-up has dissolved.
- Immediately rinse in clean water to remove acid residue.
- Replace both chambers inline so that water in circulation will flow through the oxygen chamber first then the copper chamber.
- Replace electrode cables (white to oxygen plated)

6.3 Electrode replacement

Replacement of copper plates is, preferably to be done by an e-clear certified Technician.

Method to replace copper plates:

- Switch off pool pump and e-clear system
- Undo nuts at plates to remove electrode cables
- Unscrew unions at each end of copper chamber
- Remove copper chamber
- Undo holding nuts (these may be re-used if o-rings intact)
- Slide out old copper plates, slide in new copper plates so that the plate lug sits over the hole in the PVC. Screw in bolts tightly.
- Replace chamber and tighten unions
- If leaks occur at bolt o-rings, tighten slightly
- Replace electrode cables.

It is not necessary to change oxygen plates as they are not sacrificial.

6.4 UV lamp replacement

It is preferable for this to be carried out by a qualified electrician or e-clear Technician. Switch off pool pump and unit

Carefully remove endcaps from UV chamber (be careful to not pull on wires.) Undo electrical wires from 'chocolate blocks' using a screwdriver Carefully unscrew grey threaded bush, making sure to retain o-rings. Slide out UV lamp from chamber.

Reconnect old chocolate block to new UV lamp and carefully slide new lamp into UV chamber.

Screw back grey threaded bushes making sure o-rings are re-seated. Re-attach electrical connections as before

Switch on pool pump only NOT E-CLEAR UNIT, and check for leaks.

Return endcaps

Dispose of UV lamp in accord with government regulations.

6.5 Repair/ Spares service

All local and international repairs contact: *E-clear Technologies South Africa*

Phone: Jason +27 76 611 7803

Office: +27 21 854 6356

Fax: +27 21 854 6117

Email: jason@eclearsa.com

Mail: PO Box 2308

Somerset West

7129

South Africa

Download our new E-clear App to your smartphone/tablet

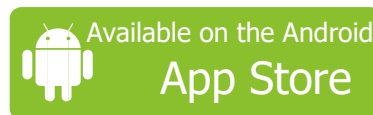

SECTION 7: CERTIFICATION AND LIMITED WARRANTY

7.1 Patent

Patent number- 2003/2934

7.2 Limited Warranty

E-clear Technologies warrants its products to the original purchaser against any defects that are due to faulty material or workmanship for a period of one year from date of shipment unless otherwise noted in the product manual.

In the event that a defect is discovered during the warranty period E-clear agrees that, at its option, it will repair or replace the defective product or refund the purchase price excluding original shipping and handling charges.

Any product repaired or replaced under this warranty will be warranted, only for the remainder of the original product warranty.

This warranty does not apply to consumable products such as lamps or Copper Electrodes.

Contact E-clear or your distributor to initiate warranty.

Products may not be returned without authorization from E-clear Tech.

Limitations:

This warranty does not cover:

Damage caused by natural disasters, labour unrest, acts of war (declared or undeclared), terrorism, civil strife, or acts of any governmental jurisdiction.

Damage caused by misuse, neglect, accident or improper application or installation. Damage caused by any repair or attempted repair not authorized by eClear Technologies Any product not used in accordance with the instructions furnished by eClear.

Freight charges to return merchandise to eClear

Freight charges on expedited or express shipment or warranted parts or products

Travel fees associated with on-site warranty repair

This warranty contains the sole express warranty made by eClear Tech.

In connection with its products. All implied warranties, including without limitation, the warranties of merchantability and fitness for a particular purpose, are expressly disclaimed.

This warranty constitutes the final, complete and exclusive statement of warranty terms and no person is authorized to make any other warranties or representations on behalf of eClear Technologies.

Limitations of Remedies

The remedies of repair, replacement or refund of purchase price as stated above are the exclusive remedies for breach of this warranty. On the basis

Of strict liability or under any other legal theory, in no event shall E-clear Technologies be liable for any incidental or consequential damages of any kind for breach of warranty or negligence.



eClear[®]

on Oxygen

Healthy Water. Healthy Earth. Healthy You.

SECTION 8:

INSTALLATION AND MAINTANCE GUIDE FOR E-CLEAR POOLS

8.1.INSTALLATION GUIDE



eClear[®]

on Oxygen

Healthy Water. Healthy Earth. Healthy You.

8.1.1. Physical Installation

Step 1

The e-Clear must only operate when the pool pump is running.

Step 2

The e-Clear system must be installed as last piece of equipment before water returns to the pool. (See diagrams above)

Step 3

The chamber should be fitted in a vertical orientation, not sideways, preferably as a "I"

Step 4

Water must flow through the ultraviolet chamber first (if installed) then the oxygen chamber and finally the ionization chamber.

Step 5

The white electrode cable attaches to the black oxygen plates. The black electrode cable attaches to the pink ionization plates. Undo cable ties and plug cable into ebox.

Step 6

Large assembly type units must be installed according to technical installation drawings guidelines.

Step 7

The entire pool volume should flow through the pool filters every 4 hours, according to international DIN standard

Step 8

e-Clear's natural oxygen process requires good water movement in your pool with no "dead" spots and deep glass media filter beds

We HIGHLY recommend only using recycled glass filter media or consol glass media, not Silica course glass media.

Step 9

All pools, whether run on chlorine, salt or e-Clear, may lose water quality from time to time under extreme load, adverse weather or other circumstances. We recommend using a hydrogen peroxide shock, non-metal based algaecide or Polysheen clarifier.

Warning

Do not add Chlorine to your pool while the e-Clear system is powered. This will damage the e-Clear system. Do not add metal based algaecide or metal remover. Whenever adding any chemicals to your water make sure the e-Clear is powered off.



Healthy Water. Healthy Earth. Healthy You.

8.1.2. Water Balancing

Once the e-Clear system is installed, proceed to balance the water.

Step 10

With the pool pump running and e-Clear system switched off, adjust the calcium hardness to 200 - 300ppm using calcium flakes (available from your local pool shop). Roughly 8 kg of Calcium Flakes per 50 000L of water renders a calcium residual of 300ppm, if calcium at 0ppm. Calcium should then only be tested once or twice a year.

Have the calcium tested at a pool shop or purchase a calcium test kit from us

Step 11

Adjust the pH to between 6.8-7.2 using hydrochloric pool acid. The water is most stable and copper ionization most effective at 6.8. Try to keep it there! Never allow the pH to rise above 7.2, the copper ions may fall out of suspension and be rendered ineffective, possibly staining your pool. The pH in gunnite or marbelite pools must therefore be maintained more strictly.

Warning

High pH will damage your electrodes and cause a build-up on your electrodes rendering the sanitization process impossible.

Step 12

Switch on the e-Clear system making sure all switches are on and all dials are at 100%. The display should show a blue oxygen reading of between 1.50 - 2.00 and a red ionization reading of between .200 - .350. If lower, check calcium or connections.

Step 13

Once switched on it should take a week or two for the copper residual to rise to the required effectivity level of 0.5ppm. To speed up the process we recommend running your pool pump and e-Clear 24 hours a day. During this time, it may be necessary to shock the water to kill algae and maintain water quality. Use hydrogen peroxide or chlorine.

Step 14

Phosphates are food for algae. They are added to your pool by municipal water, rain runoff, grass, leaves and swimmers. Phosphates should be kept at 0ppb. Use a phosphate remover, available from your pool shop.

Step 15

Test copper residual once a week using supplied copper test kit and adjust using ionic dial as necessary to maintain a residual of 0.5ppm

Step 16

Alkalinity should be kept at around 60-80ppm for best results with the e-Clear system and to maintain stable pH behaviour. A little soda bicarbonate can be added to raise alkalinity to the required level. Not more than 1kg per day. Beware this will also raise your pH.

Step 17

Once your copper level reaches 0.5ppm your pool is running on the patented e-Clear system. Run your pool pump normal hours (around 6-10 hours a day for average sized pools). You should not need to add anything except pool acid to adjust your pH.

Step 18

On a weekly basis- check pH, check copper, backwash and rinse, and perform normal pool maintenance, clean pool of leaves, grass and brush walls.

Happy swimming in your safe, healthy, soft, clean, natural pool water!

**8.1.4. TECHNICAL INSTALLATION
GUIDELIES FOR e-CLEAR
WATER SANITIZERS**

TECHNICAL INSTALLATION DRAWINGS

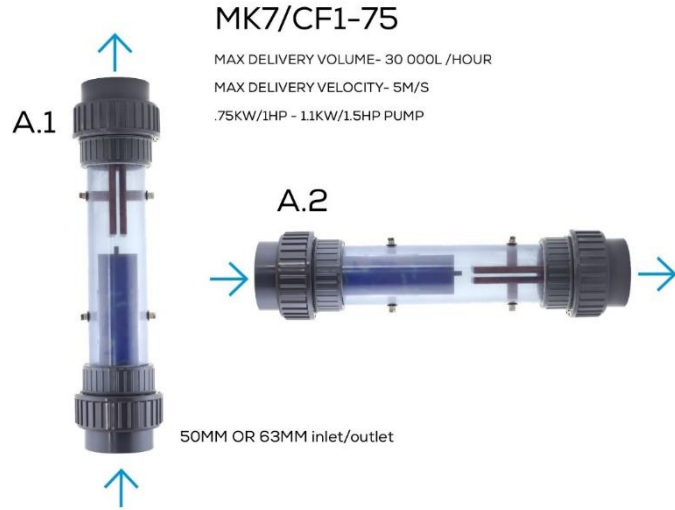

MK7/CF1-75
 MAX DELIVERY VOLUME- 30 000L /HOUR
 MAX DELIVERY VELOCITY- 5M/S
 .75KW/1HP - 1.1KW/1.5HP PUMP



MK7/CF1-150
 MAX DELIVERY VOLUME- 50 000L/HOUR
 MAX DELIVERY VELOCITY- 5M/S
 1.1KW/1.5HP- 2.2KW/3HP



MK7/CF1-75UV
 MAX DELIVERY VOLUME- 30 000L/HOUR
 MAX DELIVERY VELOCITY- 5M/S
 .75KW/1HP- 1.1KW/1.5HP PUMP



MK7/CF1-150UV
 MAX DELIVERY VOLUME- 50 000L/HOUR
 MAX DELIVERY VELOCITY- 5M/S
 1.1KW/1.5HP- 2.2KW/3HP PUMP

MK7/CF1-250



HIGH FLOW INSTALLATION

E.1

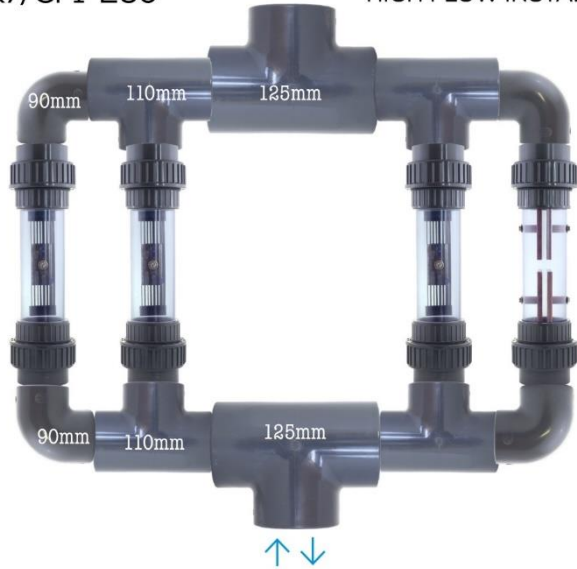

MAX DELIVERY VOLUME- 200 000L/HOUR
MAX DELIVERY VELOCITY- 10M/S
110MM OR 125MM INLET OR OUTLET

MK7/CF1-250

LOW FLOW INSTALLATION

E.3



OR

E.4



90MM INLET /OUTLET
MAX DELIVERY VOLUME- 70 000L/HOUR
MAX DELIVERY VELOCITY- 5M/S

MK7/CF1-250

LOW FLOW INSTALLATION

E.2



90MM INLET /OUTLET
MAX DELIVERY VOLUME- 70 000L
MAX DELIVERY VELOCITY- 5M/S

MK7/CF1-250

LOW FLOW INSTALLATION

E.5



OR

E.6



90MM INLET / OUTLET
MAX DELIVERY VOLUME- 70 000L/HOUR
MAX DELIVERY VELOCITY- 5M/S

MK7/CF1-250
LOW FLOW INSTALLATION



90MM INLET / OUTLET
MAX DELIVERY VOLUME- 70 000L/HOUR
MAX DELIVERY VELOCITY- 5M/S

MK7/CF1-250
LOW FLOW INSTALLATION

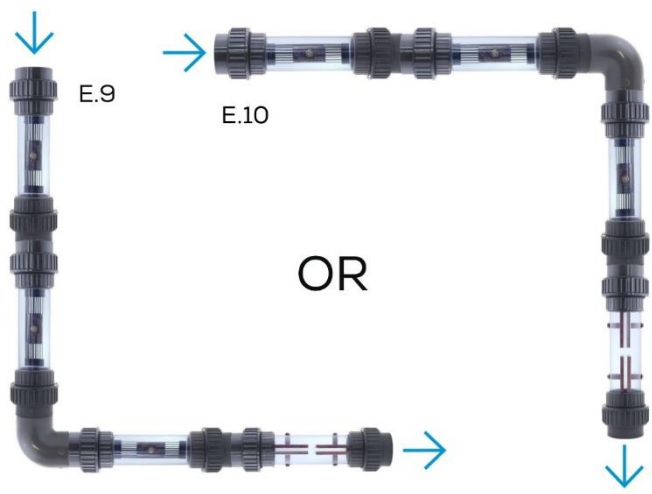

90MM INLET / OUTLET
MAX DELIVERY VOLUME- 70 000L/HOUR
MAX DELIVERY VELOCITY- 5M/S



MK7/CF1-250UV

HIGH FLOW INSTALLATION
MAX DELIVERY VOLUME- 130 000L/HOUR
MAX DELIVERY VELOCITY- 5M/S



MK7/CF1-250UV
HIGH FLOW INSTALLATION



MAX DELIVERY VOLUME- 130 000L/HOUR
MAX DELIVERY VELOCITY- 5M/S

F.3



MK7/CF1-250UV
LOW FLOW INSTALLATION

MAX DELIVERY VOLUME- 70 000L/HOUR

MAX DELIVERY VELOCITY- 5M/S

MK7/CF1-250UV
LOW FLOW INSTALLATION

F.4



MAX DELIVERY VOLUME- 70 000L/HOUR

MAX DELIVERY VELOCITY-5M/S

MK7/CF1-250UV

LOW FLOW INSTALLATION

MAX DELIVERY VOLUME- 70 000L/HOUR

MAX DELIVERY VELOCITY 5M/S

F.5



MK7/CF1-250UV

LOW FLOW INSTALLATION

F.6



MAX DELIVERY VOLUME- 70 000L/HOUR

MAX DELIVERY VELOCITY- 5M/S

MK7/CF1-500

HIGH FLOW INSTALLATION

G.1

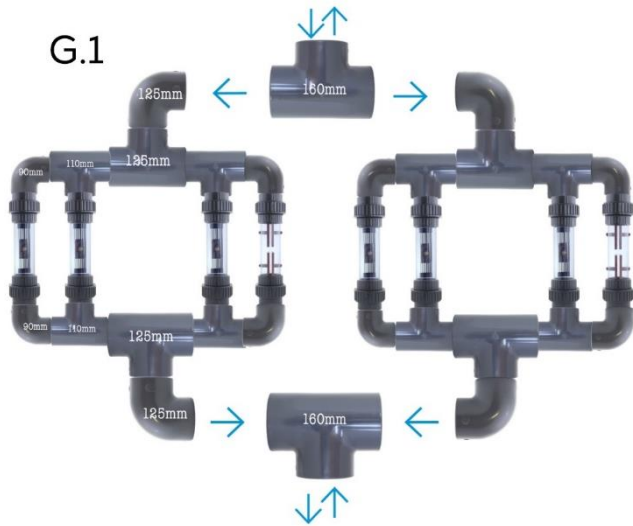

MAX DELIVERY VOLUME- 300 000L/HOUR
MAX DELIVERY VELOCITY- 10M/S

MK7/CF1-500

HIGH FLOW INSTALLATION

G.2

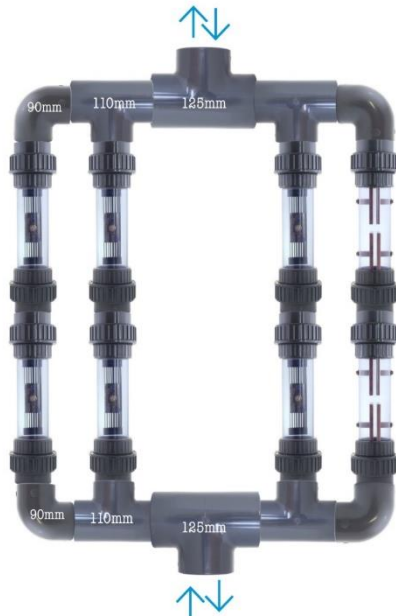

MAX DELIVERY VOLUME- 300 000L/HOUR
MAX DELIVERY VELOCITY- 10M/S

G.3



MK7/CF1-500

LOW FLOW INSTALLATION

MAX DELIVERY VOLUME- 200 000L/HOUR

MAX DELIVERY VELOCITY- 5M/S

MK7/CF1-500

LOW FLOW INSTALLATION

G.4



MAX DELIVERY VOLUME- 200 000L/HOUR

MAX DELIVERY VELOCITY- 5M/S

MK7/CF1-500

LOW FLOW INSTALLATION

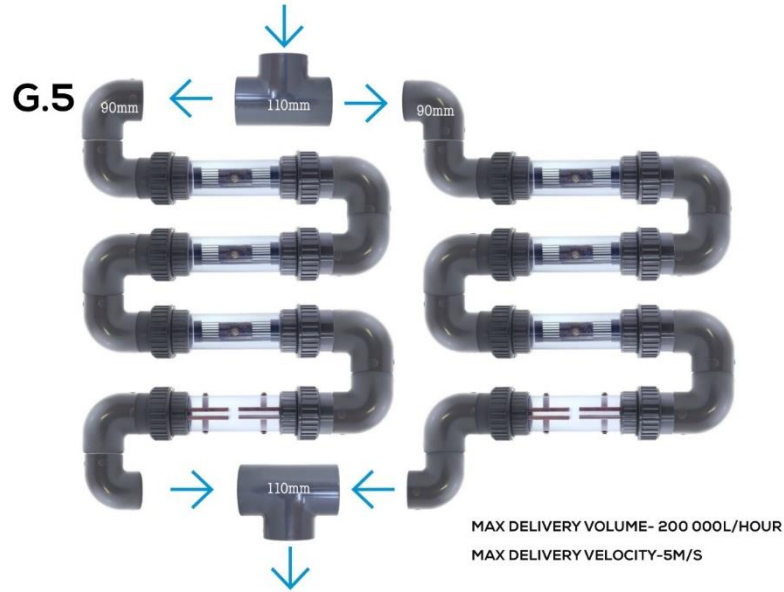

MK7/CF1-500UV

HIGH FLOW INSTALLATION WITH 2 PUMPS

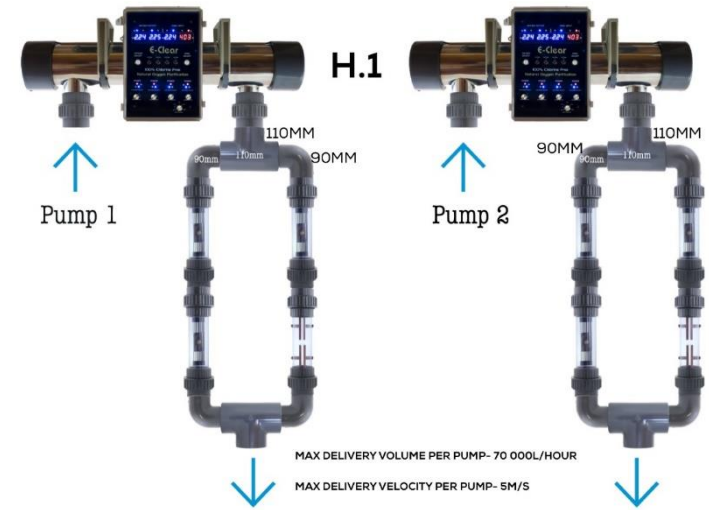

MK7/CF1-500

LOW FLOW INSTALLATION WITH 2 SEPARATE PUMPS

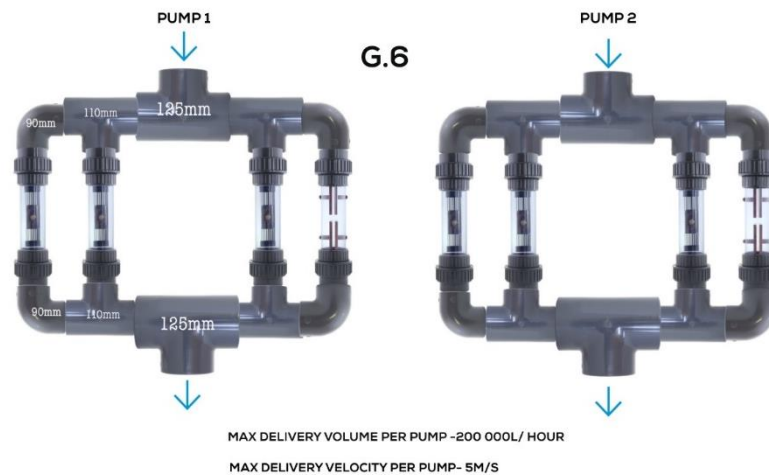

MK7/CF1-500UV

LOW FLOW INSTALLATION

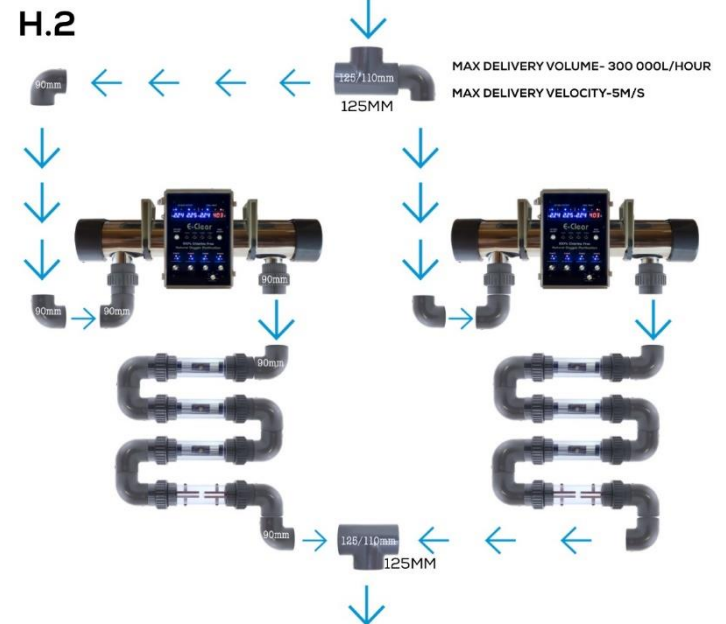

MK7/CF1-500UV
LOW FLOW INSTALLATION

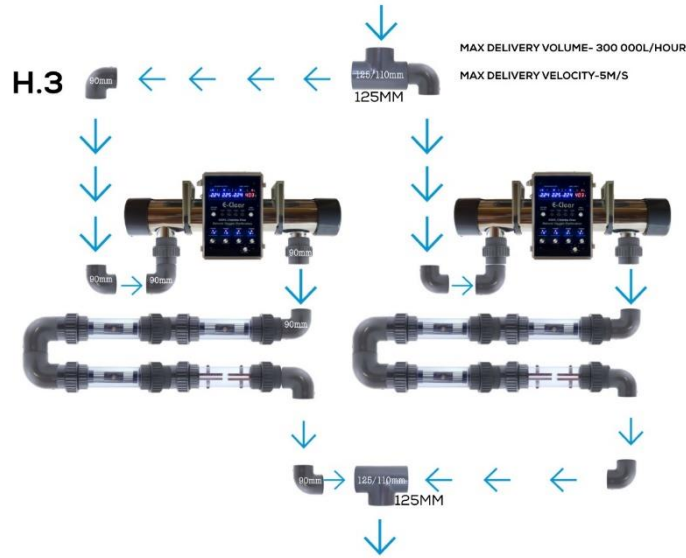

MK7/CF1-500UV
LOW FLOW INSTALLATION

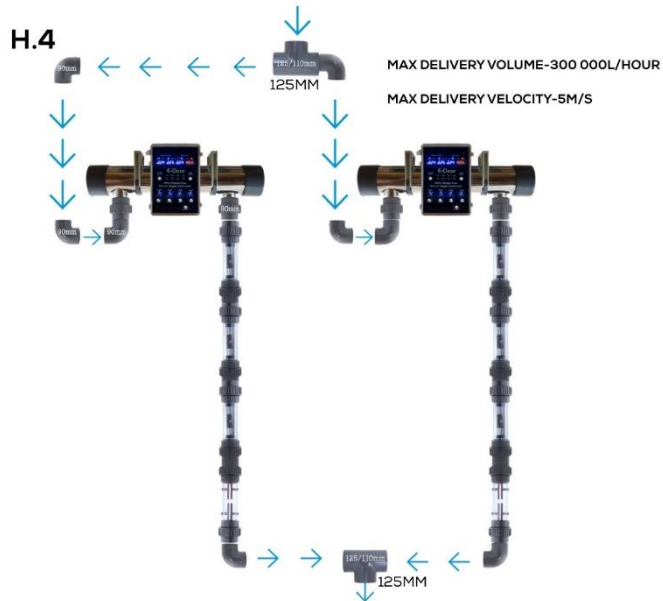

MK7/CF1-750

HIGH FLOW INSTALLATION WITH 3 PUMPS OF 3KW/5HP EACH OR LARGER

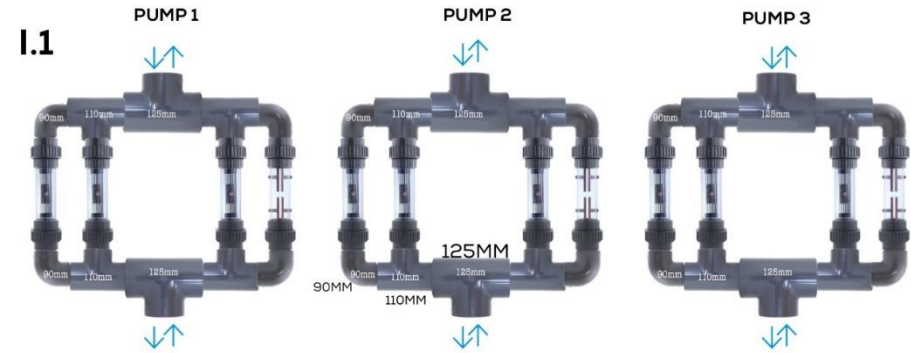

MK7/CF1-750

LOW FLOW INSTALLATION WITH 3 PUMPS OF 1.5KW/2HP EACH OR LESS



MK7/CF1-750

I.3

LOW FLOW INSTALLATION WITH 3 PUMPS OF 1.5KW/2HP EACH OR LESS

MAX DELIVERY VOLUME PER PUMP-70 000L/HOUR

MAX DELIVERY VELOCITY PER PUMP- 5M/S

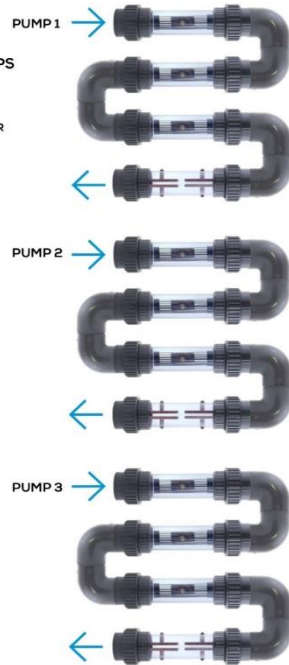

MK7/CF1-750

LOW FLOW INSTALLATION WITH 3 PUMPS OF 1.5KW/2HP OR LESS

MAX DELIVERY VOLUME PER PUMP- 100 000L/HOUR

MAX DELIVERY VELOCITY- 5M/S

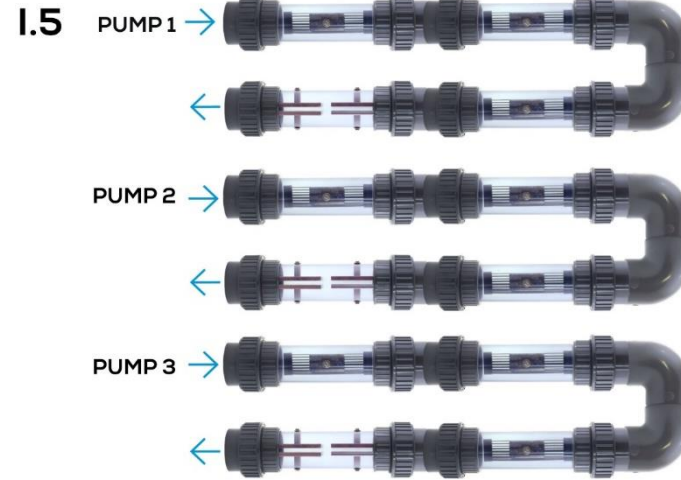

MK7/CF1-750

LOW FLOW INSTALLATION WITH 3 PUMPS OF 1.5KW/2HP EACH OR LESS

MAX DELIVERY VOLUME PER PUMP-70 000L/HOUR

MAX DELIVERY VELOCITY PER PUMP- 5M/S

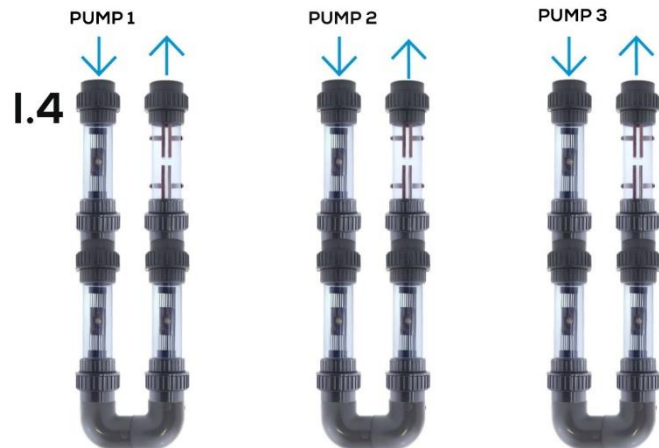

MK7/CF1-750

I.6

LOW FLOW INSTALLATION WITH 3 PUMPS OF 1.5KW/2HP OR LESS

MAX DELIVERY VOLUME PER PUMP- 100 000L/HOUR

MAX DELIVERY VELOCITY- 5M/S

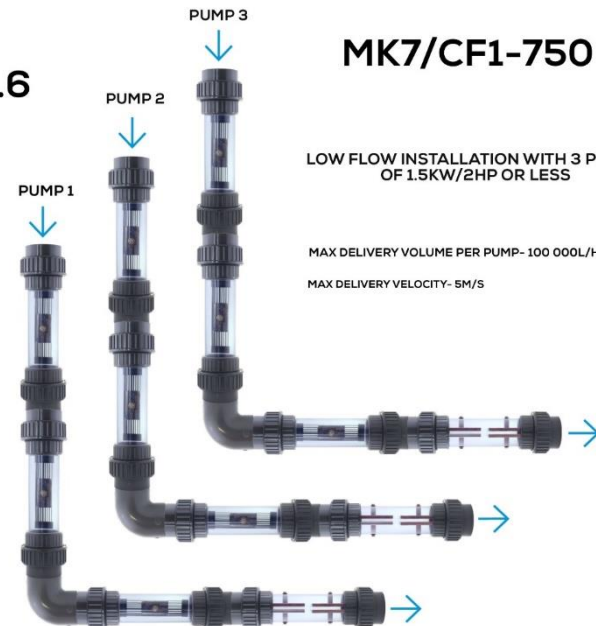

MK7/CF1-750UV

HIGH FLOW INSTALLATION WITH 3 PUMPS OF 2.2KW/3HP OR LESS

J.1

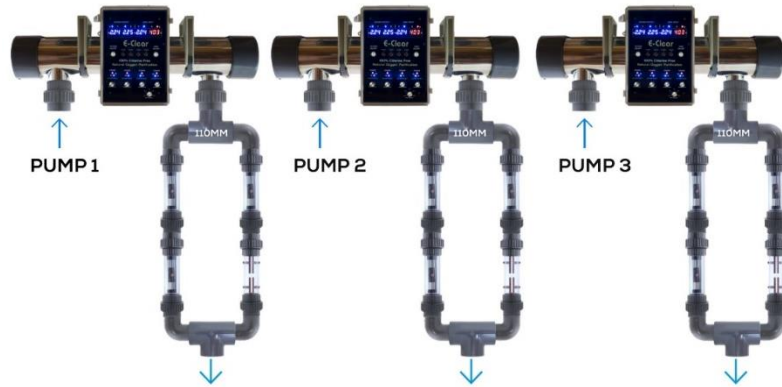

MAX DELIVERY VOLUME PER PUMP- 200 000L/HOUR

MAX DELIVERY VELOCITY- 5M/S

MK7/CF1-750UV

HIGH FLOW INSTALLATION WITH 3 PUMPS OF 2.2KW/3HP

J.2

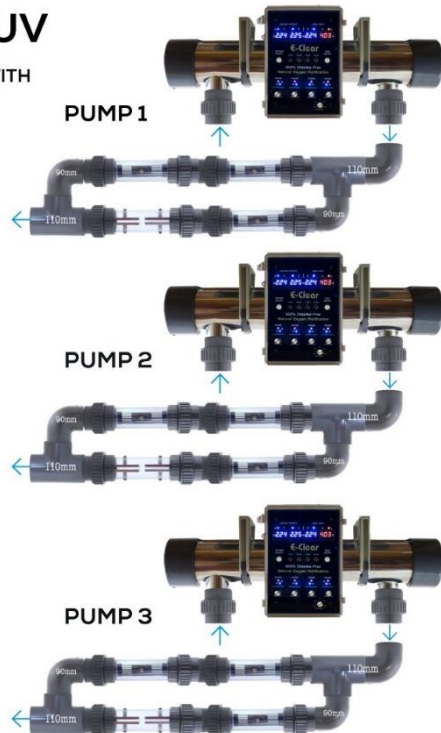

MAX DELIVERY VOLUME PER PUMP-200 000L/HOUR

MAX DELIVERY VELOCITY- 5M/S

MK7/CF1-750UV

LOW FLOW INSTALLATION WITH 3 PUMPS OF 1.5KW/2HP OR LESS

J.3

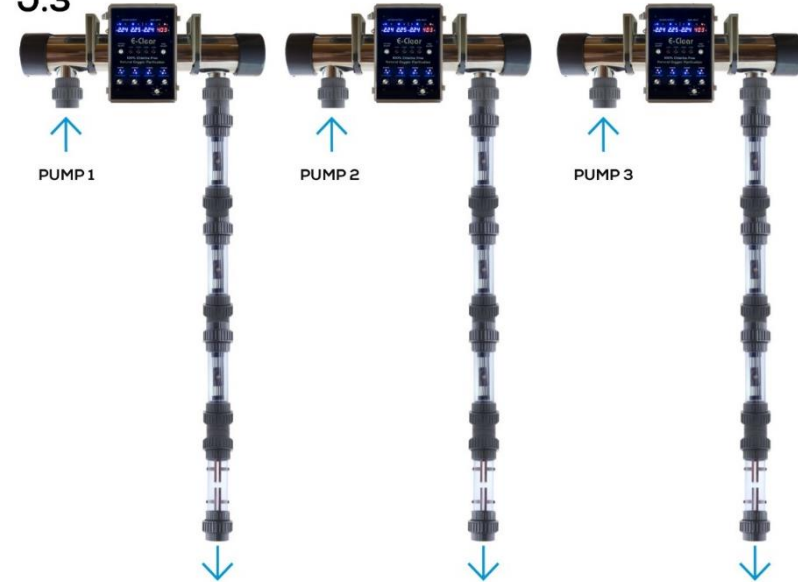

MAX DELIVERY VOLUME PER PUMP- 130 000L/HOUR

MAX DELIVERY VELOCITY-5M/S

MK7/CF1-750UV

LOW FLOW INSTALLATION WITH 3 PUMPS OF 1.5KW/2HP OR LESS

J.4

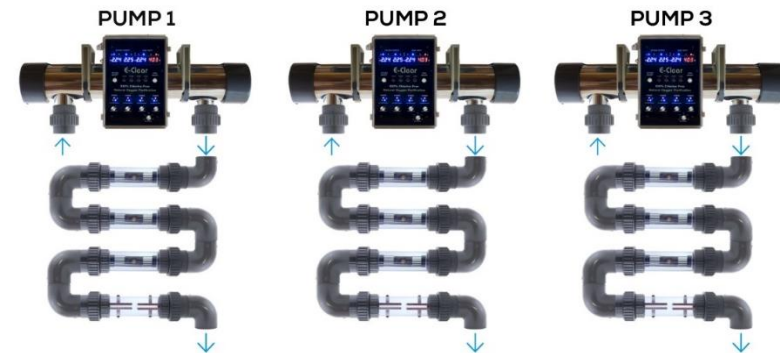

MAX DELIVERY VOLUME PER PUMP-130 000L/HOUR

MAX DELIVERY VELOCITY-5M/S

MK7/CF1-750UV

LOW FLOW INSTALLATION WITH 3 PUMPS OF 1.5KW/2HP OR LESS

MAX DELIVERY VOLUME PER PUMP- 130 000L/HOUR

MAX DELIVERY VELOCITY-5M/S

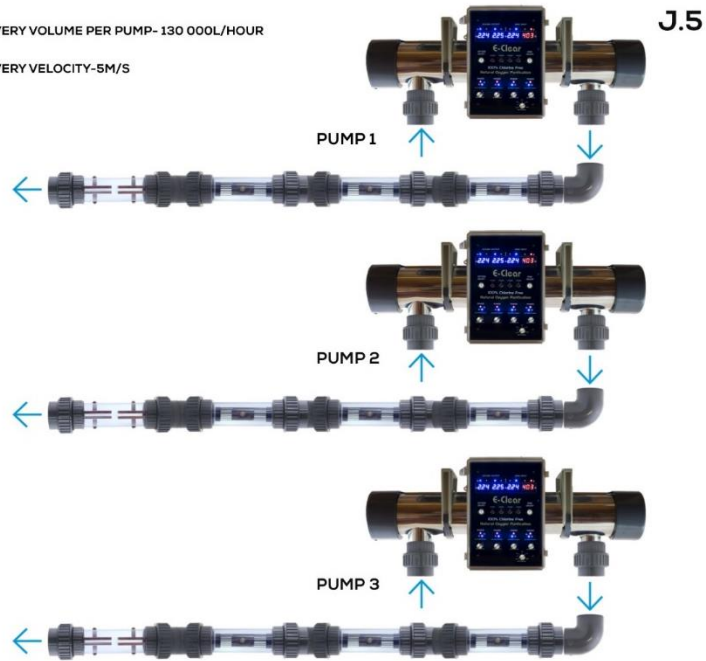

MK7/CF1-1000UV

HIGH FLOW INSTALLATION WITH 2 PUMPS OF 3KW/4HP OR LESS

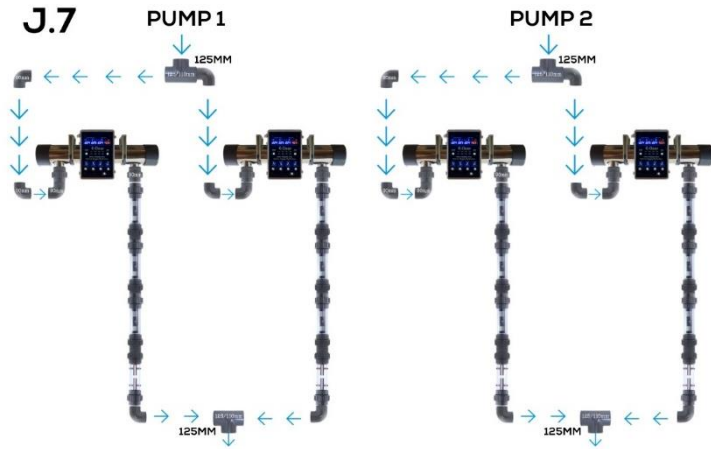

MAX DELIVERY VOLUME PER PUMP-300 000L/HOUR

MAX DELIVERY VELOCITY-10M/S

MK7/CF1-1000

HIGH FLOW INSTALLATION WITH 3 PUMPS OF 2.2KW/3HP OR LESS

MAX DELIVERY VOLUME PER PUMP-200 000L/HOUR

MAX DELIVERY VELOCITY-10M/S

MK7/CF1-1000UV

HIGH FLOW INSTALLATION WITH 2 PUMPS OF 3KW/4HP OR LESS

MAX DELIVERY VOLUME PER PUMP-300 000L/HOUR

MAX DELIVERY VELOCITY-10M/S

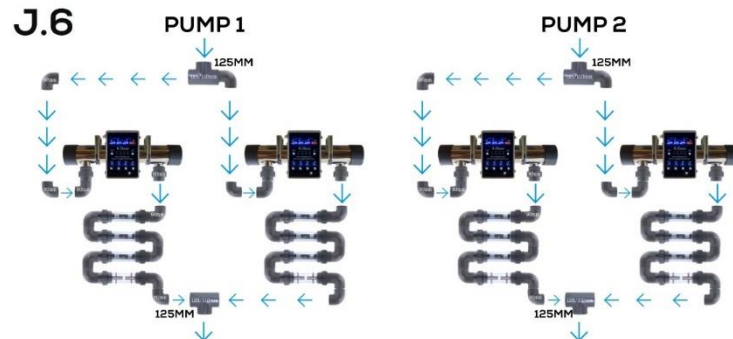

K.1

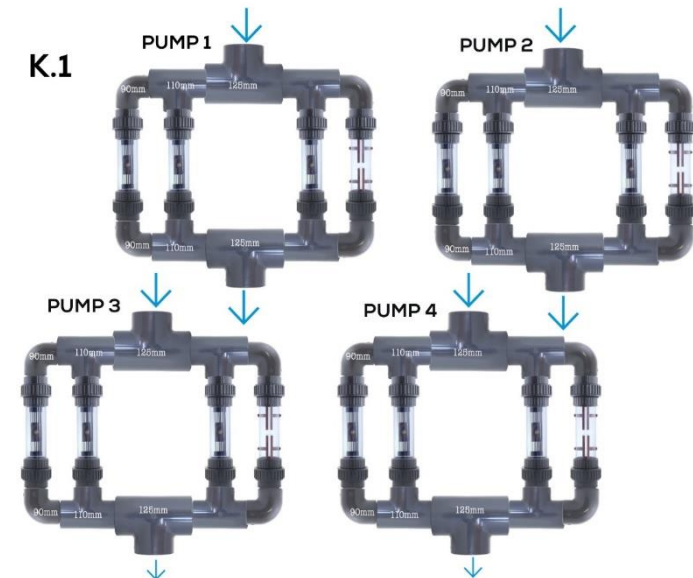

MK7/CF1-1000

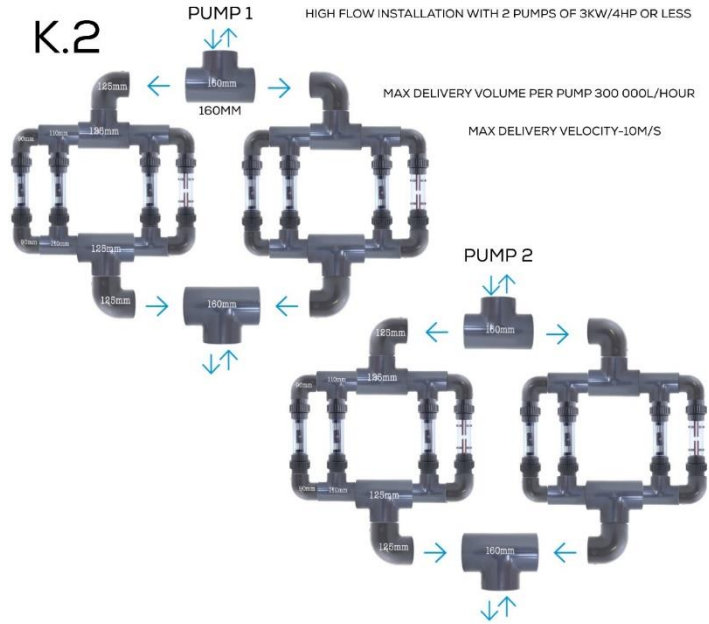

MK7/CF1-1000

HIGH FLOW INSTALLATION WITH 2 PUMPS OF 3KW/4HP OR LESS

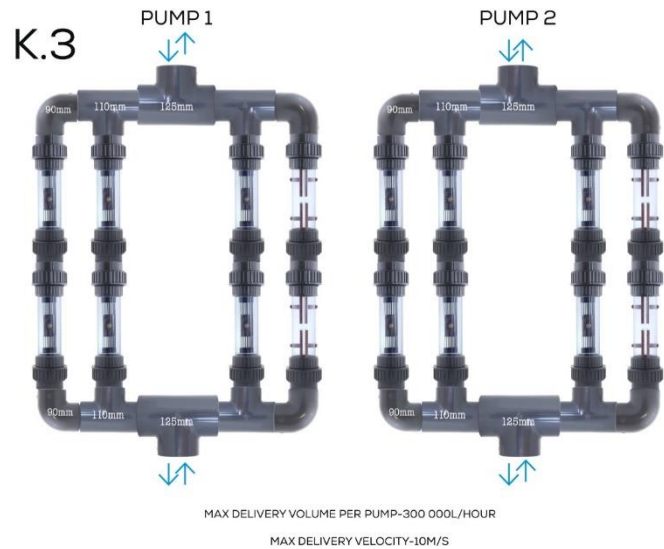

MK7/CF1-1000

LOW FLOW INSTALLATION WITH 4 PUMPS OF 1.5KW/2HP EACH OR LESS



MAX DELIVERY VOLUME PER PUMP- 70 000L/HOUR

MAX DELIVERY VELOCITY PER PUMP- 5M/S

MK7/CF1-1000

K.5

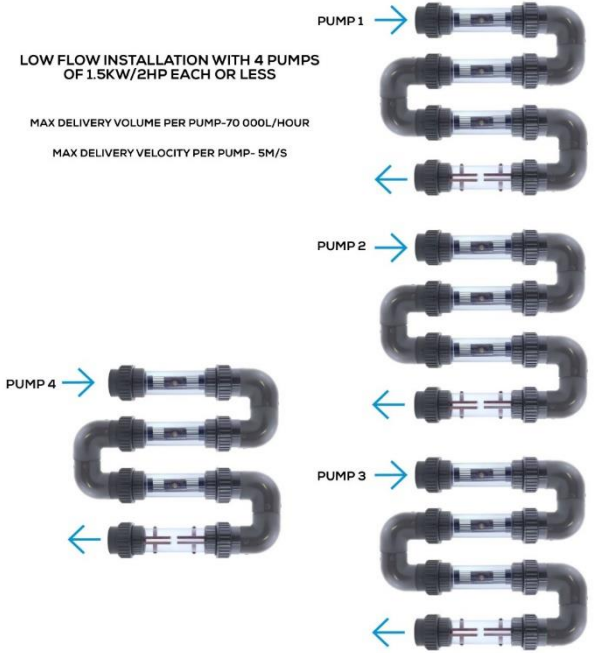

MK7/CF1-1000

LOW FLOW INSTALLATION WITH 4 PUMPS OF 1.5KW/2HP EACH OR LESS

K.6

MAX DELIVERY VOLUME PER PUMP-70 000L/HOUR
MAX DELIVERY VELOCITY PER PUMP- 5M/S

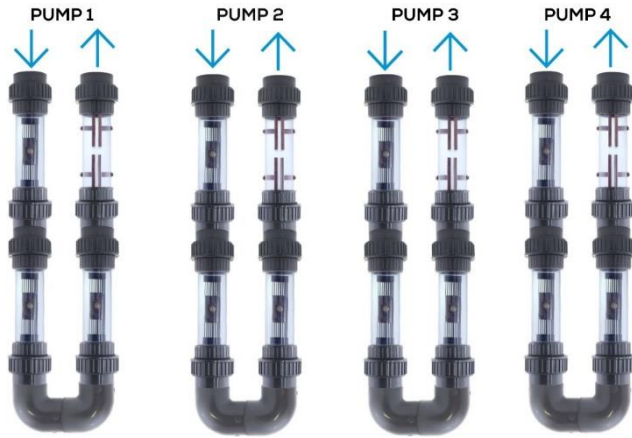

K.7

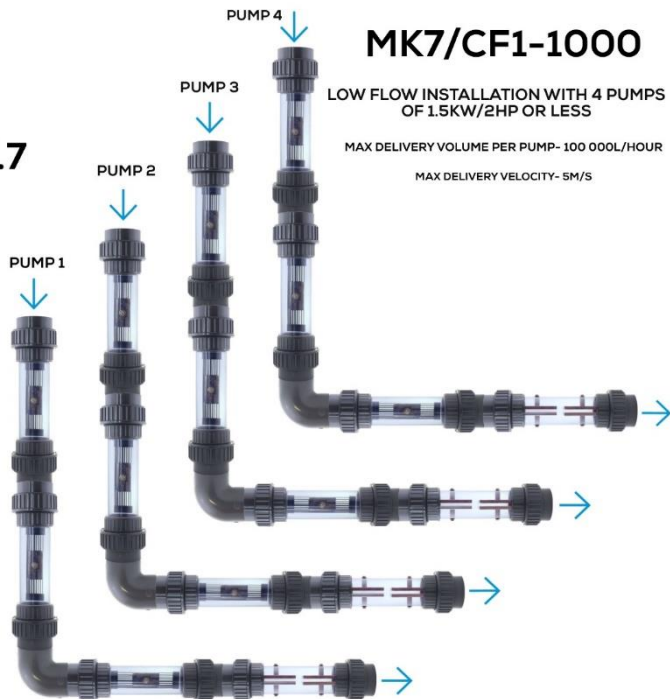

MK7/CF1-1000

LOW FLOW INSTALLATION WITH 4 PUMPS OF 1.5KW/2HP OR LESS

MAX DELIVERY VOLUME PER PUMP- 100 000L/HOUR
MAX DELIVERY VELOCITY- 5M/S

MK7/CF1-1000UV

HIGH FLOW INSTALLATION WITH 4 PUMPS OF 2.2KW/3HP OR LESS

L.1

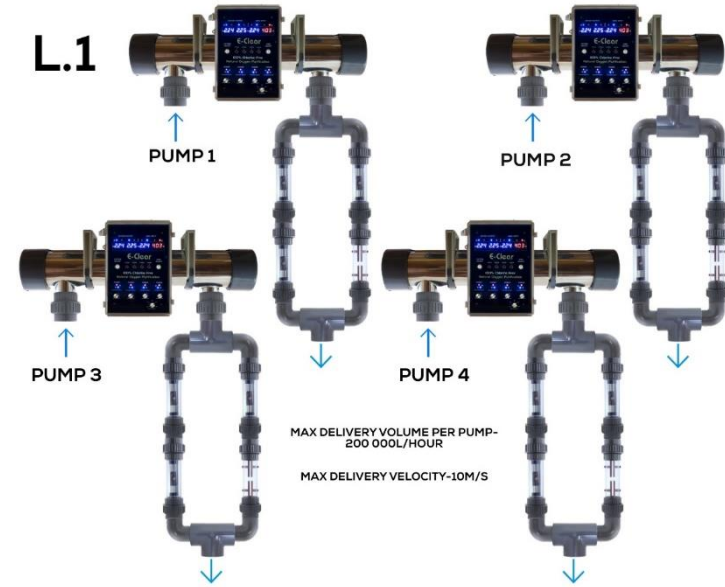

MAX DELIVERY VOLUME PER PUMP- 200 000L/HOUR
MAX DELIVERY VELOCITY-10M/S

MK7/CF1-1000UV

HIGH FLOW INSTALLATION WITH 4 PUMPS OF 2.2KW /3HP OR LESS

L.2

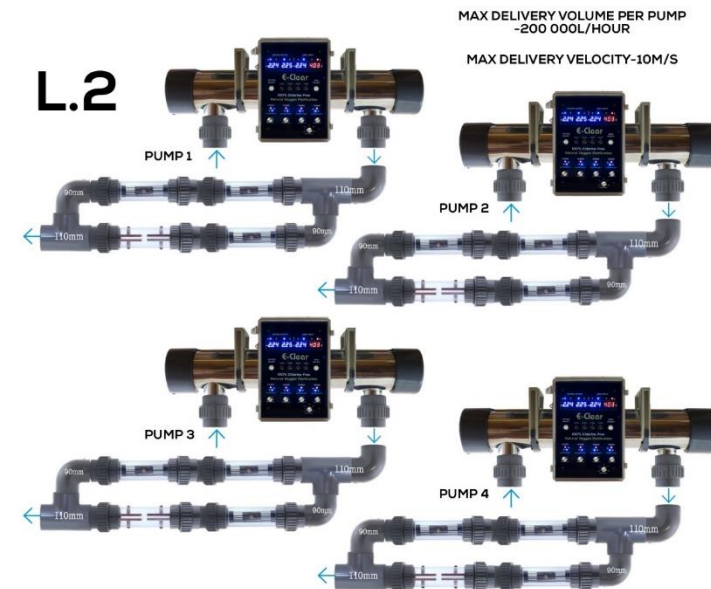

MAX DELIVERY VOLUME PER PUMP -200 000L/HOUR
MAX DELIVERY VELOCITY-10M/S

MK/CF1-1000UV

LOW FLOW INSTALLATION WITH 4 PUMPS OF 2.2KW/3HP OR LESS

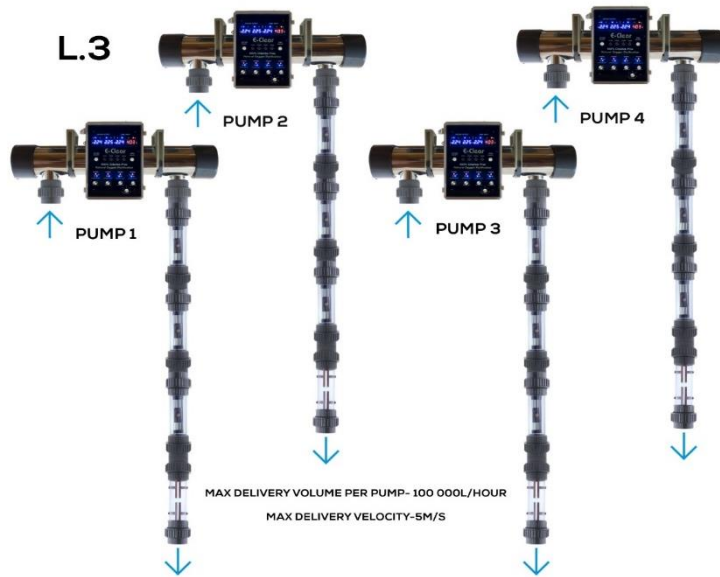

MK7/CF1-1000UV

LOW FLOW INSTALLATION WITH 4 PUMPS OF 2.2KW/3HP OR LESS

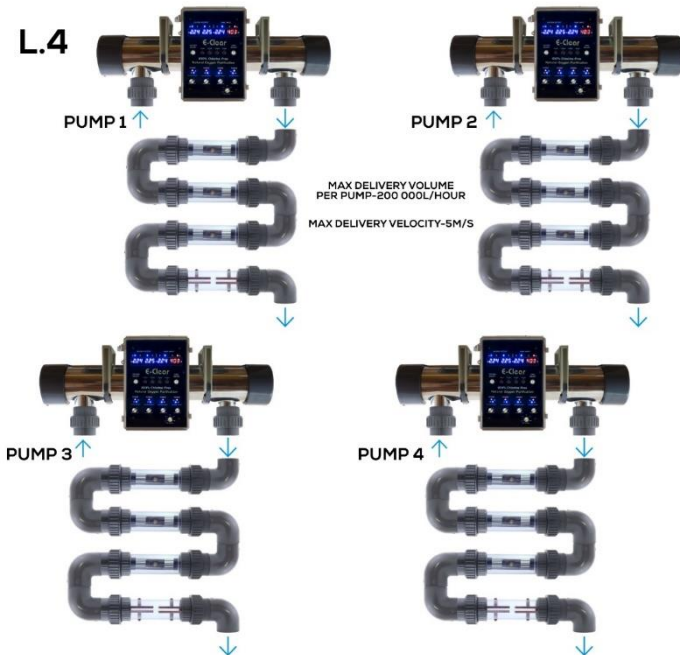

MK7/CF1-1000UV

LOW FLOW INSTALLATION WITH 4 PUMPS OF 2.2KW/3HP OR LESS

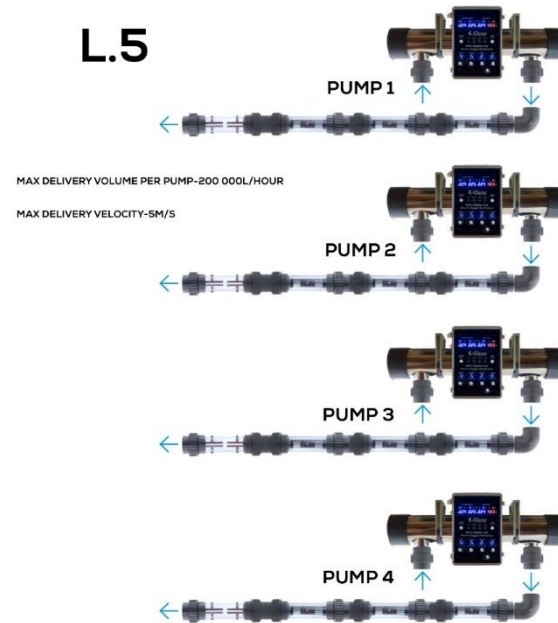

8.2.MAINTENANCE GUIDE



Healthy Water. Healthy Earth. Healthy You.

The e-Clear system is NOT maintenance free BUT IT IS Chlorine free, salt free and ozone free!

8.2.1. Weekly Maintenance

Normal pool maintenance is required

1. Backwash and rinse filter
2. Brush pool walls
3. Net out all floating debris
4. Vacuum up all debris on the pool floor
5. Adjust the pH to between 6.8-7.2 using hydrochloric acid
6. Check copper residual using supplied copper test kit. The test kit will only give true results if the pH is between 6.8-7.2. Adjust copper on e-Clear control box via on/off switch or ionization percentage dial. If test kit shows copper residual to be at the required 0.5ppm then switch off or turn down the copper ionization on the e-Clear control box. If copper residual is below 0.5ppm then switch on/ turn up the copper ionization on the e-Clear control box. The copper MUST be checked and adjusted weekly.
7. Visually check your unit's milliamp reading. Blue number should be between 1.60 and 2.25. Red reading- .200 - .350
8. Visually check oxygen and copper plates for dirt, build-up and check copper plates thickness. Once they reach under 4mm thick they should be replaced.

8.2.2. Annual Maintenance

1. Check calcium level of pool water at pool shop or using e-Clear purchased calcium test kit. Calcium Level should be between 200-300ppm. Calcium is added at e-Clear installation to produce conductivity in the water in order for the plates to pass current between them. Calcium does not get used up or evaporate but only leaves the pool during back washing. Thus only needs to be checked every year.
2. Clean the electrodes, if necessary, by removing each electrode chamber and immersing in hydrochloric acid / water solution of 1-part acid to 10 parts water, until the buildup has dissolved. Not more than 20 min.
3. Change pool filter glass media every 18 months. We recommend Consol glass media of grit size 0.6mm-2mm. This is finer than normal pool glass media.

8.2.3. Water Parameters

Ideal Water Parameters

pH 6.8-7.2 (preferably 7.0)

ALKALINITY 80-120 PPM

CALCIUM HARDNESS 250-400 PPM

COPPER RESIDUAL 0.5PPM

PHOSPHATES 0 PPB

CYANURIC ACID 0 PPM

TEMPERATURE UP TO 38°C



Healthy Water. Healthy Earth. Healthy You.

8.2.4. DO'S AND DONT'S

ALKALINITY

e-Clear pools need low alkalinity, unlike chlorine pools. This is because our system changes the chemical make-up of the calcium in the water into bicarbonate. Therefore, alkalinity should never need be raised in e-Clear pools after initial setup.

pH and alkalinity are closely linked, alkalinity is defined as the ability of the water to resist pH changes. Therefore, **if your alkalinity is too low you may need to add large amounts of pool acid very often.**

pH

A pH of 6.8 results in more stable water parameters. Never allow pH to rise above 7.2 as this renders the e-Clear's hydrolysis and ionization ineffective.

Prolonged high pH levels or low pH levels may damage your plates and also allow calcium deposits to build up on your plates which will then require removal and manual cleaning in an acid solution. High alkalinity causes the pH to drift upwards quickly.

CALCIUM

Calcium is added at e-Clear installation to produce conductivity in the pool water so that an electrical charge can travel between the electrodes. 250-400ppm is necessary. Have water tested 1 week after installation for calcium.

Too little calcium will prevent proper operation of the e-Clear system. **Low calcium hardness can promote pool corrosion. High calcium can cause the water to appear cloudy.**

PHOSPHATES

Phosphates are food for algae. If you have an algae problem and your copper residual is at 0.5ppm then you may have a phosphate problem. Phosphates are added by leaves, grass and other organic material as well as by people, dogs and clothing washed in certain detergents.

Test the phosphates at a pool shop and add a phosphate remover.

A non-metal based algaecide can be added.

A peroxide based shock may be necessary to kill algae blooms.

ALGAE

Algae blooms occur when pH is lower than 6.8 and higher than 7.2 or the copper residual is lower than 0.5ppm

If algae occurs in your pool, check phosphates, adjust pH, check copper.

Dead spots in your pool where water doesn't move freely, e.g., steps or square corners, are susceptible to algae growth, regularly brush walls in these areas.

Floating or substrate based algae can be controlled by adding non-metal based algaecide said and shocking the water using peroxide based treatments.

Also, check filter glass media, replace glass media if older than 18 months.

Fitting a larger pump and filter will solve almost all algae problems and most water quality issues.



Healthy Water. Healthy Earth. Healthy You.

CYCLE TIMES

When water quality is an issue, run the e-Clear system 24 hours a day to clear up the water.
At start up run the e-Clear 24 hours a day until copper residual reaches 0.5ppm
Thereafter run the e-Clear **6-12 hours a day** during daylight hours, under normal circumstances.

FILTER SIZES- MINIMUM

- Pools under 50 000L - 4 bag filter + 0.75kw pump
 - Pools between 50 000 to 100 000L - 5 bag filter + 1.1kw pump
 - Pools from 100 000L to 150 000L - 7 bag filter + 1.5 kW pump.
- The entire pool water volume should flow through the filter within **4 hours**.*

CLOUDY WATER

Upon installation, the e-Clear system will descale previous build ups of calcium from your pipes, filter, heater and other pool equipment. This may cause your water to appear cloudy. This should stop in a month or two. If it does not, then consider changing your filter glass media.



Healthy Water. Healthy Earth. Healthy You.



Healthy Water. Healthy Earth. Healthy You.

8.2.5. Common Issues

"I can't get my copper to rise..."

At start up, running your pool 24 hours a day, it may take a couple of weeks to attain the desired copper residual of 0.5ppm

During this setup period you will need to treat your water with a peroxide based shock to keep the water free of algae and bacteria.

If copper still won't rise, test calcium, if below 250ppm raise using calcium FLAKES.

Copper won't ionize if pH is above 7.4

"My pool water is green..."

Is pH above **7.3**? Reduce to 6.8 using pool acid.

Is copper above 1ppm? Replace 25% of your pool water or add metal remover.

Shock the pool using peroxide based shock

You should never need to add chlorine to the pool but if you must. Add chlorine to a bucket of pool water, stir and let it stand for 10 min. Add water with e-Clear system off. - **Never add chlorine to the pool while the e-Clear system is powered, it will cause an electrical surge and damage your plates.**

8.2.6. What can I add to my e-Clear pool

DO NOT ADD

- **Chlorine** - can damage the plates and you!
- **Salt**
- **Zeolite** glass media
- Any **metal based** algaecide
- Hardly ever **soda bicarbonate** except at start up
- Soda ash
- Alkalinity-up products
- Copper powder
- Metal removers
- Gravel filter glass media larger than 2mm grit

YOU MAY USE

- Hydrogen peroxide neat or as part of a peroxide shock
- Flocculant, clarifier or gel block to clear cloudy water from suspended micro solids
- Hydrochloric, muriatic acid to reduce pH
- Calcium FLAKES only, not powder or liquid
- Soda bicarbonate to raise alkalinity initially, not more than 2kgs per day.
- Non-metal based algaecide
- Phosphate removers
- Alum treatment as a flocculant but must be carried out by a professional
- Consol glass filter glass media, grit size 0.6

SECTION 9:

PROBLEM SOLVING GUIDE

PROBLEMS WITH POOL

A. WATER

A.1 CLOUDY WATER

REASONS

A.1.1. SAND

CAUSE

Dirty sand – Sand clogged, not catching finer particles.

SOLUTION

Change sand immediately to consul glass fine or recycled glass media.

A.1.2. DE-CALCIFYING WALLS

CAUSE

Years of hard water build up is being dissolved by the eClear's electronic oxidation.

SOLUTION

Decalcification will stop after a few weeks.

A.1.3. HOT WEATHER

CAUSE

Extra swimmers
Extra pollutants.

SOLUTION

Increase the time the pool pump, filter and eClear oxidation runs.

Check conductivity/calcium hardness – 200ppm increase.

A.2 GREEN WATER

REASONS

A.2.1. ALKILINITY

CAUSE

Too low 60ppm below.

SOLUTION

Add baking soda/ soda bicarb. 500g every 4 days until 80ppm-120ppm.

A.2.2. HIGH pH

CAUSE

Above 7.4

SOLUTION

Add HYDROCHLORIC/MURIATIC ACID or SODIUM BISULPHATE.

A.2.3. DIRT IN POOL

CAUSE

Raises pH, increase algae growth, reduce oxidation reduction potential (ORP).

SOLUTION

Clean pool - Brush walls, vacuum bottom, net out leaves, backwash & rinse filter.

A.2.4. UV LAMPS OLD

CAUSE

Waterborne suspended algae leads to water borne suspended algae.

SOLUTION

Add algaecide as per label.

A.3 NOT SPARKLING

REASONS

A.3.1 HIGH TEMPERATURE/ HIGH BODYLOAD

CAUSE

Extra pollution.

SOLUTION

Run pump, filter & eClear longer each day for better filtration & sanitization.

Check calcium/conductivity

A.3.2. SUSPENDED MICRO PARTICLES

CAUSE

Various reasons.

SOLUTION

Run pump, filter & eClear longer each day for better filtration & sanitization.

Check calcium/ conductivity as above.

A.1 CLOUDY WATER

REASONS

A.1.4. HIGHER SWIMLOAD

CAUSE

Extra pollutants to be oxidized.

SOLUTION

Check conductivity/calcium hardness – 200ppm increase

A.1.5. SUSPENDED MICRO PARTICLES

CAUSE

Due to extra swimmers/pollution or dirty sand.

Sand grit too large.

SOLUTION

Add flocculant/gel block or we recommend polysheen blue.

Install finer sand – consul glass (grit 0.6 – 2mm) or glass media.

A.1.6. POOR FILTRATION

CAUSE

Total pool volume turnover is less than every 4 hours perhaps due to roof heating panels.

SOLUTION

Install larger pump & filter to filter total volume every 4 hours, taking into account roof heating panels.

A.2 GREEN WATER

REASONS

A.2.5. LOW OXIDATION

CAUSE

Suspended algae pollutants not being oxidized and feeding algae phosphate.

SOLUTION

Shock pool using chlorine/H2O2 and increase hours the eClear runs per day.

Check calcium hardness – 200ppm.

A.2.6. LOW COPPER RESIDUAL

CAUSE

Copper residual below 0.5ppm thus cannot kill algae.

SOLUTION

Switch ON copper until 0.5ppm is recorded using copper test kit.

Check calcium if copper is always ON yet cannot reach 0.5ppm residual.

B. WALLS

B.1 ALGAE REASONS

B.1.1. ALKILINITY

CAUSE

Alkalinity too high, above 120ppm. Results in reduced sanitizer efficiency – allowing algae to grow.

SOLUTION

Add small amounts of pool acid over the course of a few weeks to eat up the alkalinity
Brush walls & add algaecide.

B.1.2. DEAD SPOTS IN POOL

CAUSE

No water movement in certain areas of pool due to lack of returns, allowing algae to flourish.

SOLUTION

Install more returns and large pumps.
Brush affected areas regularly
Add algaecide.

B.1.3. LOW COPPER RESIDUAL

CAUSE

Under 0.5ppm allows algae to grow.

SOLUTION

Brush walls and add algaecide.
Switch ON copper to raise.
Check conductivity/ calcium hardness – raise to 200ppm using calcium chloride flakes.
Check if copper plates need replacing if less than 3mm thick.

B.2 STAINS REASONS

B.2.1. BLACK/GREY STAINS ON WALLS OR PURPLE

CAUSE

Over oxidation stains.

SOLUTION

Run eClear fewer hours per day.
Do not add other oxidizers (chlorine/ bromine peroxide) directly onto walls.

B.2.2. BLACK STAINS

CAUSE

Not a stain but algae.

SOLUTION

Make sure copper residual is 0.5ppm
Add algaecide.
Brush walls immediately.

B.2.3. GREEN/ BLUE SATINS

CAUSE

Very high copper residual and/or high pH has caused copper ions to fall out of suspension and adhere to calcium based substrates.

SOLUTION

TO PREVENT
Make sure copper residual doesn't go above 0.5ppm.
Adjust pH to 6.8-7.2
TO TREAT
Lower pH to 6.8.
Add metal remover

B.3 GROUTING REASONS

B.3.1. GREEN

CAUSE

Very high copper residual and/or high pH has caused copper ions to fall out of suspension and adhere calcium based substrates.

SOLUTION

TO PREVENT
Make sure copper residual doesn't go above 0.5ppm.
Adjust pH to 6.8-7.2
TO TREAT
Lower pH to 6.8.
Add metal remover

B.3.2. BLACK

CAUSE

Not a stain but algae.

SOLUTION

Make sure copper residual is 0.5ppm
Add algaecide.
Brush walls immediately.

B.3.3. CRUMBLING

CAUSE

Low pH.

SOLUTION

Increase pH to 7.2
Raise alkalinity.

B.1 ALGAE

REASONS

B.1.4. BAD MAINTENANCE

CAUSE

Pollutants not removed releases phosphates which feeds algae growth.

SOLUTION

Brush walls, net out grass/leaves. Vacuum bottom at least weekly.
Add algaecide.

C. OTHER

C.1. SOLAR BLANKETS

CAUSE

Inhibits oxygen being dissolved into the water from the atmosphere thereby lowering the total dissolved oxygen content.

SOLUTION

Use non-solid pool covers or use the eClear oxy-booster valve from increased dissolved oxygen content.

C.4. BURNING EYES

CHLORAMINES - Install UV lamps which destroys chloramines.

LOW ALKALINITY - Raise by using soda bicarb.

HIGH ALKALINITY - Lower using pool acid.

C.2. BUILDUP ON PLATES

CAUSE

Calcium hardness may be too high thus inhibiting the eClear AOP and Ionization functions.

SOLUTION

Clean plates by immersing in acid solution until clean. 1-part acid to 10-part water.
Needs regular maintenance.

C.5. STRONG SMELL

CAUSE

High chloramines.

SOLUTION

Install UV system.

C.3. LOW MILLIAMP READOUT

DIRTY PLATES - Clean plates by immersing in acid solution until clean. 1 Acid to 10 pools water. Needs regular maintenance.

LOW CONDUCTIVITY - Add calcium to raise hardness to 200ppm.

COPPER PLATES TOO THIN - If less than 3mm thick - REPLACE

C.6 HIGH ACID DEMAND

CAUSE

High alkalinity

SOLUTION

Alkalinity is too high. This is normal on new plaster pools for up to 1 year, solution lower total alkalinity to about 60ppm.

D. CHEMICALS

D.1. CHEMICALS TO NEVER USE

ZEOLITE - Absorbs copper ions.

SALT - Not necessary.

METAL BASED ALGAECIDE - Gives false copper test reading.

SODA ASH - Raises alkalinity too much.

COPPER POWDER - Gives false copper test results.

LARGE GRIT FILTER SAND - Will leave water cloudy.

D.2. CHEMICALS YOU MAY USE

FLOCCULANT - To clear cloudy water.

Generic gel blocks add as per label instructions.

Polysheen – Highly recommended, highly concentrated.

HYDROCHLORIC/MURIATIC ACID/

CITRIC ACID - Lowers pH.

CALCIUM CHLORIDE FLAKES (ONLY) - To raise conductivity and thereby increase eClear milliamp reading

PHOSPHATE REMOVER - As per instructions.

HYDROGEN PEROXIDE - As per instructions.

CHLORINE - Mix thoroughly and pour into weir. Switch eClear OFF when adding.

GLASS MEDIA - More efficient than sand. Filters out smaller particles than sand.

SODA BICARBONATE - Add NO MORE than 1kg per day to raise alkalinity.

ALGAECIDE - ONLY Non-metal based algaecides.

SILICA SAND - Fine grit 0.6-2mm

OXALIC (STAIN REMOVER) - To remove oxidation stains.

CYANURIC (STABILIZER) - Has no effect on eClear pools.

SODIUM HYPOCHLORIDE - As directed on shock treatment.

OXICLEAR - Non-Chlorine shock 30g/10000L per week.

SECTION 10:

SPARE PARTS



Healthy Water. Healthy Earth. Healthy You.

10.1 SPARE PARTS

OXYGENATION AND IONIZATION

MK-75

QUANTITY	UNIT	LIFE SPAN
2	63mm IONIZATION ELECTRODES	1-3 YEARS

MK-150

QUANTITY	UNIT	LIFE SPAN
2	90mm IONIZATION ELECTRODES	1-3 YEARS

MK-250

QUANTITY	UNIT	LIFE SPAN
4	90mm IONIZATION ELECTRODES	1-3 YEARS

MK-500

QUANTITY	UNIT	LIFE SPAN
8	90mm IONIZATION ELECTRODES	1-3 YEARS

MK-750

QUANTITY	UNIT	LIFE SPAN
12	90mm IONIZATION ELECTRODES	1-3 YEARS

MK-1000

QUANTITY	UNIT	LIFE SPAN
16	90mm IONIZATION ELECTRODES	1-3 YEARS

ULTRAVIOLET REACTION CHAMBERS

SINGLE UV

QUANTITY	UNIT	LIFE SPAN
1	55 WATT UVC HIGH SPECTROTHERM LAMP	10 000 HOURS

TWIN UV

QUANTITY	UNIT	LIFE SPAN
2	55 WATT UVC HIGH SPECTROTHERM LAMP	10 000 HOURS

QUAD UV

QUANTITY	UNIT	LIFE SPAN
4	55 WATT UVC HIGH SPECTROTHERM LAMP	10 000 HOURS

10.2. OXYGENATION, IONIZATION AND UV

MK-75UV

QUANTITY	UNIT	LIFE SPAN
2	63mm IONIZATION ELECTRODES	1-3 YEARS
1	55 WATT UVC HIGH SPECTROTHERM LAMP	10 000 HOURS

MK-500UV

QUANTITY	UNIT	LIFE SPAN
8	90mm IONIZATION ELECTRODES	1-3 YEARS
8	55 WATT UVC HIGH SPECTROTHERM LAMP	10 000 HOURS

MK-150UV

QUANTITY	UNIT	LIFE SPAN
2	90mm IONIZATION ELECTRODES	1-3 YEARS
2	55 WATT UVC HIGH SPECTROTHERM LAMP	10 000 HOURS

MK-750UV

QUANTITY	UNIT	LIFE SPAN
12	90mm IONIZATION ELECTRODES	1-3 YEARS
12	55 WATT UVC HIGH SPECTROTHERM LAMP	10 000 HOURS

MK-250UV

QUANTITY	UNIT	LIFE SPAN
4	90mm IONIZATION ELECTRODES	1-3 YEARS
4	55 WATT UVC HIGH SPECTROTHERM LAMP	10 000 HOURS

MK-1000UV

QUANTITY	UNIT	LIFE SPAN
16	90mm IONIZATION ELECTRODES	1-3 YEARS
16	55 WATT UVC HIGH SPECTROTHERM LAMP	10 000 HOURS



e^oClear

on Oxygen

SECTION 11:

DRINKING WATER SYSTEMS



Healthy Water. Healthy Earth. Healthy You.

11.1. Can you trust eClear™

eClear Technologies has been making eClear™ systems for over 20 years. We export to around 30 countries worldwide, with more than 25 000 installations.

eClear's natural oxygenator (O₂) technology delivers over 40,000g oxidation/hr making it the most powerful water treatment system currently available. Unlike chlorine systems, eClear generates no harmful chloramine gas or toxic disinfection by products (DBPs).

Using an advanced electrolysis process the eClear oxygenator technology generates powerful natural oxidizers, hydroxyl (OH), atomic oxygen (O₁), hydrogen peroxide (H₂O₂) and oxygen (O₂) from the water molecules itself.

The powerful oxidizers, OH, O₁ and H₂O₂ combined with O₂ and copper, effectively inactivates algae, viruses, bacteria, yeast, fungi and protozoa.

The wars of the next 20 years will be fought over water. Fact. Many countries face water shortages and water throttling, including South Africa, starting in 2016.

An average house roof in South Africa catches and wastes around 120 000l of rainwater per year. About half of a large families' annual consumption (250 000l). Besides saving money, when the water goes off in your neighbourhood, you can have uninterrupted, full pressure, drinking water at every tap in your home. You won't even know the municipal water is switched off!

The eClear eco-fusion rainwater harvesting system incorporates everything necessary, as a kit, to fully harvest all the rainwater from your home's roof, then sanitize it and deliver high pressure, fully purified drinking water to your entire home, no matter how large.

It is made up of the 7 stage Eco-Fusion water sanitization purification system, along with a 10 000l storage tank and an optional extra 5 000l storage tank, as well as all the necessary pumps, pipes and valves. You also have the option of filling up the tank with municipal water during the non-rainy season in case of water throttling.

The recirculation system incorporating the patented eClear technology will keep your water clean by only having to run the recirculation pump about 1-2 hours a day.

Water is a necessity. However, it isn't guaranteed anymore. Take control of your water needs, don't rely on anyone else to do so. The eClear eco-fusion rainwater harvesting system does just that.

ECO-FUSION™ ONE-TAP

DRINKING WATER

SYSTEM



Healthy Water. Healthy Earth. Healthy You.

11.2. ECO-FUSION™ ONE-TAP DRINKING WATER SYSTEM

ECLEAR® ONE-TAP™ UNDERCOUNTER ULTRAVIOLET DRINKING WATER SYSTEM



SUPER LONG LIFE UV LAMP, 5 MICRON AND CARBON FILTER
SUPER COMPACT, SIMPLE DESIGN

11.2.1. 10" BIG BLUE FILTER HOUSING

Large capacity housing suitable for high flow applications. Accepts 4 1/2 diameter cartridges.

Big Blue housing® filter housings offer the versatility to meet all of your large-capacity filtration needs, including high-flow and heavy- sediment applications. The extra-large housing allows for greater cartridge capacity, reducing the number of vessels required for high flow-rate applications. Sumps are constructed of durable reinforced polypropylene and is available in 20" lengths.

The high-flow polypropylene (HFPP) cap is available with 3/4", 1" on 1 1/2" NPT inlet and outlet ports. The 1 1/4" internal port allows a greater volume of liquid to pass through the HFPP cap more rapidly. Big Blue housings are compatible with a broad range of chemicals.

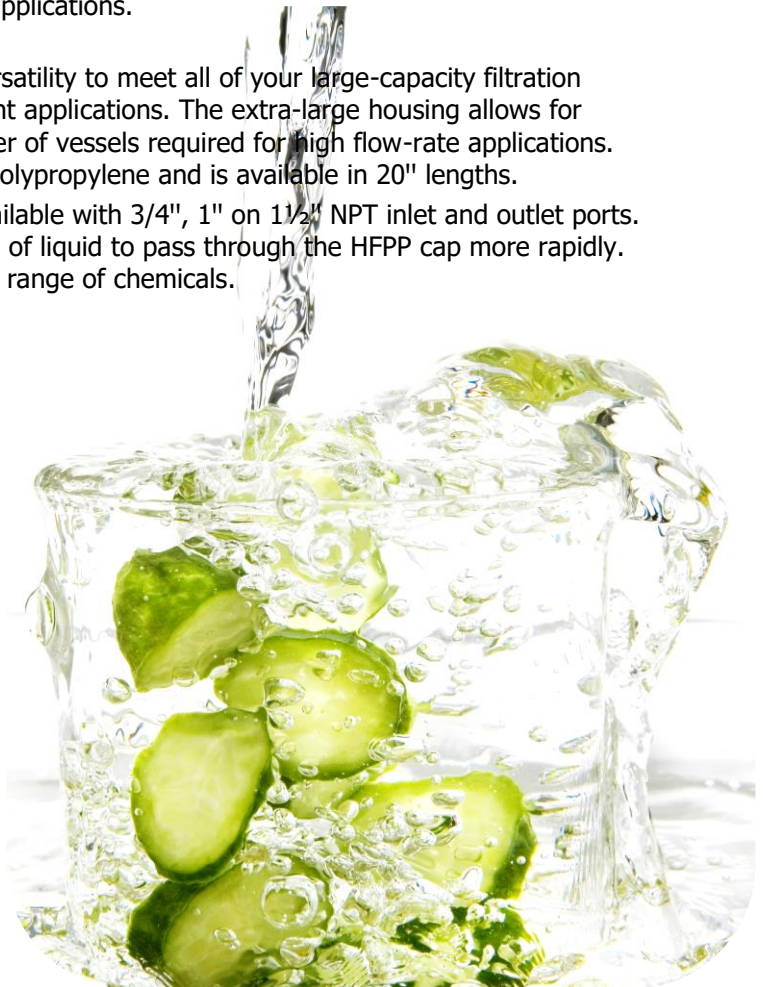
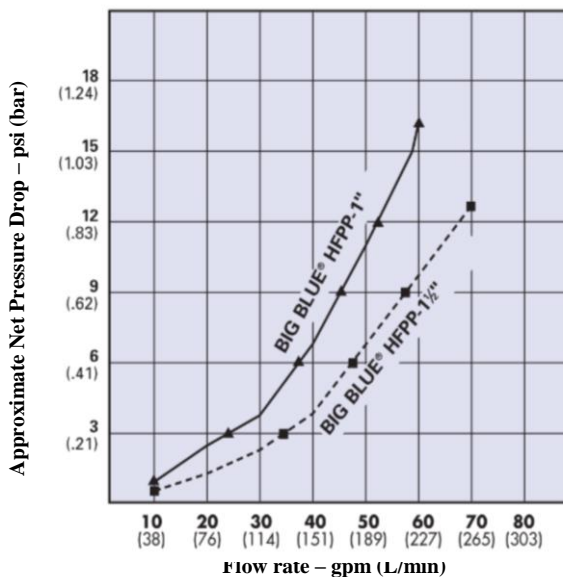

HOUSING SPECIFICATIONS AND PERFORMANCE DATA

MODEL	MAXIMUM DIMENSIONS	INITIAL AP (psi) @ FLOW RATE (gpm)
10" BB-1"	13-1/8" x 7-1/4" (333 mm x 184 mm)	1 psi @ 15 gpm (0.1 bar @ 57 L/min)

MATERIALS OF CONSTRUCTION

Housing	Polypropylene	O-Ring	Bana-N
Cap	Polypropylene (HFPP)	Maximum Temperature	100°F (37.8°C)
Button Assembly	300 series Stainless Steel, EPDM and Polypropylene	Maximum Pressure	#10 BB – 100 psi (6.9 bar)

11.2.2. MELTBLOWN 5 MICRON PRE-FILTER

HAD Series-High Performance and absolutely depth Melt Blown Filter

The HAD Series-High Performance and Absolutely Depth Filter is manufactured using no glue, this product shows advantages on the gradient of rating providing more micron rating rates and a cartridge that is stronger than the general melt blown filters. This makes micron rating more accurate.



SPECIFICATIONS

DIMENSIONS	MATERIAL OF CONSTRUCTION	PERFORMANCE
Outside Diameter: 4.5" (115mm) Inner Diameter: 1.2" (30mm) Length: 10" (254mm)	Filter Media: Polypropylene (PP) End Caps: Polypropylene (PP) Cores: Polypropylene (PP) Gasket/O-Ring: Silicon, EPDM, NBR, VITON	Removal Rating: 5µm Max Operating Temperature: 180°F (82°C)



11.2.3. 10" BIG BLUE CARBON BLOCK FILTERS

Our Activated Carbon Filter Cartridges are formed using extruding carbon fibers and food-grade binders. This makes it FDA approved for the Food/Beverage industry. It also ensures that no bad taste is left behind. This filter is also great for filtering organic matter effectively.



Healthy Water. Healthy Earth. Healthy You.

SPECIFICATIONS

DIMENSIONS	MATERIAL OF CONSTRUCTION	PERFORMANCE
Outside Diameter: 4.5" (115mm) Inner Diameter: 1.2" (30mm) Length: 10" (508mm)	Filter Media: Acid washed bituminous GAC & water washed coconut shell GAC End Caps Material: Polypropylene Gasket: Silicone, EPDM, NBR Netting: Polypropylene	Removal Rating: 5µm Max Differential Pressure: 7 Bar @ 68°F (20°C) Max Operating Temperature: 125°F (52°C)

11.2.4. UV T5 16W HIGH OUTPUT UVC WITH QUARTZ SLEEVE

TUV TL Mini are slim double-ended UVC (germicidal) lamps used in residential water and air disinfection units. The small 16mm diameter of the lamp allows for small system design and design flexibility. TUV TL Mini lamps offer almost constant UV output over their complete lifetime, for maximum security of disinfection and high system efficacy.

PRODUCT DATA

GENERAL INFORMATION

Cap-Base	4PINSSINGLEENDED
(4 Pins Singe Ended)	
Bulb Shape	T5 (T5)
Main Application	Disinfection
Useful Life (Nom)	900 h
System Description	na [-]

LIGHT TECHNICAL

Color Code-	[Not Specified]
Color Designation-	[Not Specified]
Lumen Depreciation at-	15% useful lifetime

OPERATING AND ELECTRICAL

Power (Rated)	15 W
(Nom)	

Lamp Current (Nom)	0.4 A
Voltage (Nom)	86 V
Mechanical and Housing	
Cap-Base Information	4 Pins Single Ended

UV

UV-C Radiation	4.0 W
----------------	-------

PRODUCT DATA

Full product code	871150064385899
Order product name	TUV 16W 4P SE UNP/32
EAN/UPC – Product	8711500643858
Order Code	385419
Numerator – Quantity per pack	1
Numerator – Packs per outer box	32
Material Nr. (12NC)	927971404099
Net Weight (Piece)	36.000 g

ECO-FUSION™ WHOLE HOUSE

DRINKING WATER SYSTEMS

11.3.ECO-FUSION™ WHOLE HOUSE DRINKING WATER SYSTEMS

A. FOR: NORMAL WATER



B. FOR: HIGH IRON/ BOREHOLE WATER

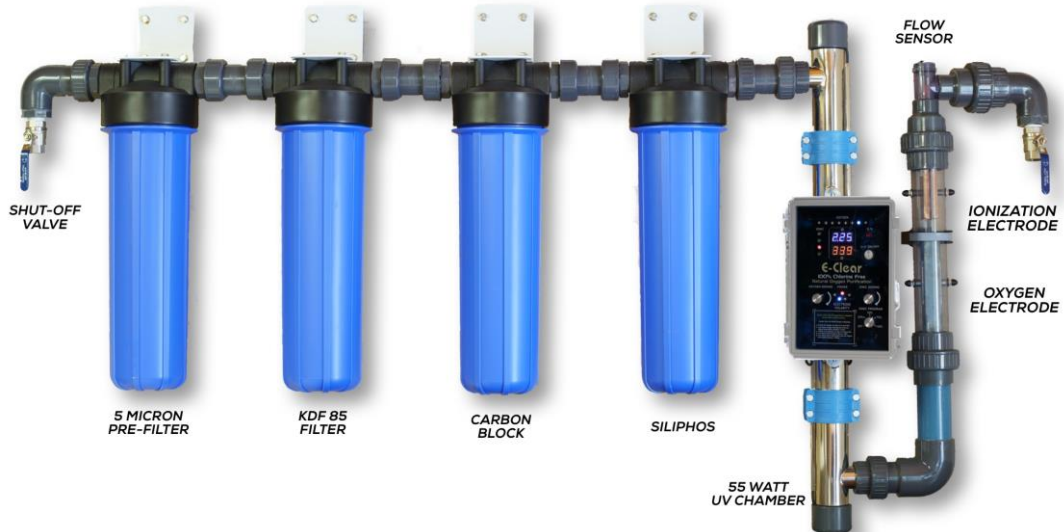

C. FOR: HARD WATER/ LIMESCALE



11.3.1. Eco-Fusion™ Drinking Water Systems Technical Specifications

SHUT OFF VALVES:	Enables Shut Down of Mains Water for Easy Cartridge Replacement and Maintenance of System.
ULTRAVIOLET CHAMBER:	Extended Chamber for longer contact time to water. Removes 99.9% of all waterborne parasites and diseases-including the deactivation of cryptosporidium. Special long life High Spekthrotherm Germicidal UV lamps. 5000hrs.
ELECTRONIC MANAGEMENT UNIT:	Microprocessor Technology with Integrated Digital Display. Auto Boost for increased current dosing of Oxygen/Ionization electrodes. Electronic UV Lamp Ignition and "Lamp Failure Indicator. Digital Display indicators for Dosing Output of Oxygen/Ionization. Fully Programmable SECAM System.
FLOW SENSOR:	Fully Integrated Flow Sensor ON/OFF Management of system. Activates Entire System when Tap is Turned ON. Deactivates System when tap is turned OFF thus Reducing Electrical Consumption and Extending UV lamp life and Electrodes. Fully Programmable for High Demand Water- Usage.
FLOW RATE:	Approx. 4000 liters per Hour.
ELECTRICAL:	1: Amp Draw/@ 230-240volts/50HZ = 1 Amp 2: Volts 220-240V Single Phase Operation
INSTALLATION SIZE + WEIGHT	1.6Metres x 1Metre. 37kgs Total Volume When Packed 150cm x 70cm x 60cm

11.3.2. SYSTEM COMPONENTS



11.3.2.1. 20" BIG BLUE HIGH FLOW FILTER HOUSING

Large capacity housing suitable for high flow applications. Accepts 4 1/2" diameter cartridges.

Big Blue housing® filter housings offer the versatility to meet all of your large-capacity filtration needs, including high-flow and heavy-sediment applications. The extra-large housing allows for greater cartridge capacity, reducing the number of vessels required for high flow-rate applications. Sumps are constructed of durable reinforced polypropylene and is available in 20" lengths.

The high-flow polypropylene (HFPP) cap is available with 1 1/2" NPT inlet and outlet ports. The 1/4" internal port allows a greater volume of liquid to pass through the HFPP cap more rapidly.

Big Blue housings are compatible with a broad range of chemicals.

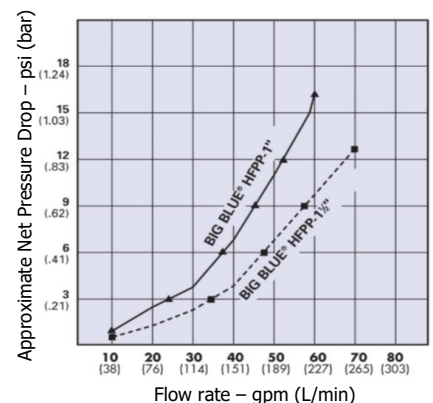

HOUSING SPECIFICATIONS AND PERFORMANCE DATA

MODEL	MAXIMUM DIMENSIONS	INITIAL AP (psi) @ FLOW RATE (gpm)
20" BB-1 – 1/2"	23 – 7/8" x 7 – 1/4" (606 mm x 184 mm)	1 psi @ 20 gpm (0.1 bar @ 76 L/min)

MATERIALS OF CONSTRUCTION

Housing	Polypropylene	O-Ring	Bana-N
Cap	Polypropylene (HFPP)	Maximum Temperature	100°F (37.8°C)
Button Assembly	300 series Stainless Steel, EPDM and Polypropylene	Maximum Pressure	#20 BB – 90 psi (6.2 bar)

11.3.2.2. MELTBLOWN 5 MICRON PRE-FILTER

HAD Series-High Performance and absolutely depth Melt Blown Filter

The HAD Series-High Performance and Absolutely Depth Filter is manufactured using no glue, this product shows advantages on the gradient of rating providing more micron rating rates and a cartridge that is stronger than the general melt blown filters. This makes micron rating more accurate.



SPECIFICATIONS

DIMENSIONS	MATERIAL OF CONSTRUCTION	PERFORMANCE
Outside Diameter: 4.5" (115mm) Inner Diameter: 1.2" (30mm) Length: 20" (508mm)	Filter Media: Polypropylene (PP) End Caps: Polypropylene (PP) Cores: Polypropylene (PP) Gasket/O-Ring: Silicon, EPDM, NBR, VITON	Removal Rating: 5µm Max Operating Temperature: 180°F (82°C)



Healthy Water. Healthy Earth. Healthy You.

11.3.2.3. 20" BIG BLUE CARBON BLOCK FILTERS

Our Activated Carbon Filter Cartridges are formed using extruding carbon fibers and food-grade binders. This makes it FDA approved for the Food/Beverage industry. It also ensures that no bad taste is left behind. This filter is also great for filtering organic matter effectively.

SPECIFICATIONS

DIMENSIONS	MATERIAL OF CONSTRUCTION	PERFORMANCE
Outside Diameter: 4.5" (115mm) Inner Diameter: 1.2" (30mm) Length: 20" (508mm)	Filter Media: Acid washed bituminous GAC & water washed coconut shell GAC End Caps Material: Polypropylene Gasket: Silicone, EPDM, NBR Netting: Polypropylene	Removal Rating: 5µm Max Differential Pressure: 7 Bar @ 68°F (20°C) Max Operating Temperature: 125°F (52°C)

11.3.3. KDF FILTERS

KDF process media, however, improve water treatment performance by protecting, and in some cases replacing, existing filtration/purification technologies. The exceptional filtration/purification performance and versatility of KDF media make them an economical and easy-to-use water treatment technology in both new systems and retrofit applications.

Improve your system's economy while improving performance.

When used alone, KDF media can remove more than 95% of chlorine, iron, heavy metal, and other contaminants from water.

When used in combination with granular activated carbon (GAC), KDF media can significantly extend the life of the carbon.

Compared to other water treatment technologies, KDF process media offer reduced materials requirements resulting in more compact and more economical systems.

Because KDF process media contains no chemical additives and are 100% recyclable, costly disposal requirements are eliminated. What's more, KDF process media are safer for the environment.

KDF process media are high-purity, copper-zinc formulations that reduce contaminants in water using an oxidant/reduction (redox) reaction.

In other words, KDF media exchange electrons with contaminants, changing them into harmless components. For example, chlorine is changed into soluble, soluble ferrous cations are changed into insoluble ferric hydroxide, and hydrogen sulfide is changed into insoluble copper sulfide.

Other heavy metals such as mercury, copper and nickel are removed simply by bonding o the KDF media. Microorganisms, however, are controlled two ways:

1. The exchange of electrons in the redox reaction creates an electrolytic field that most microorganisms can't survive.
2. KDF process media may catalyze the formation of radicals and peroxides in certain circumstance. The radicals can interfere with microorganisms' ability to function.



TYPICAL REDOX REACTIONS

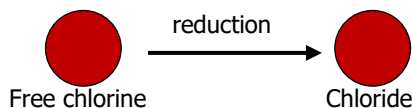

Harmful chlorine is removed by changing free chlorine into chloride ions

KDF PROCESS MEDIA PRODUCT SPECIFICATIONS	
Medium composition	Atomized high purity copper/zinc alloy
Color	Golden (55), reddish brown (85)
Physical form	Granular
Screen size (U.S mesh)	-10 +100
Particle size range	0.149mm – 2.00mm
Apparent density	2.2 – 2.9 g/cc (171 lbs./cu.ft.)
Turbidity	<20 ntu
Skid	48 – 1/3 cu.ft. drums (2,736 lbs.)
Odor and taste	None
Recommended Operating Conditions (use 3 – cycle valve):	
Service flow	15 gpm/sq. ft
Backwash for 10 min @	30 gpm/sq. ft
Purge/ rinse for 30 min. @	Maximum
Bed expansion, backwash	10 – 15 %
Free board	20 %
Minimum bed depth (6" dia.)	10 inch
pH range: drinking water	6.5 – 8.5



NSF International

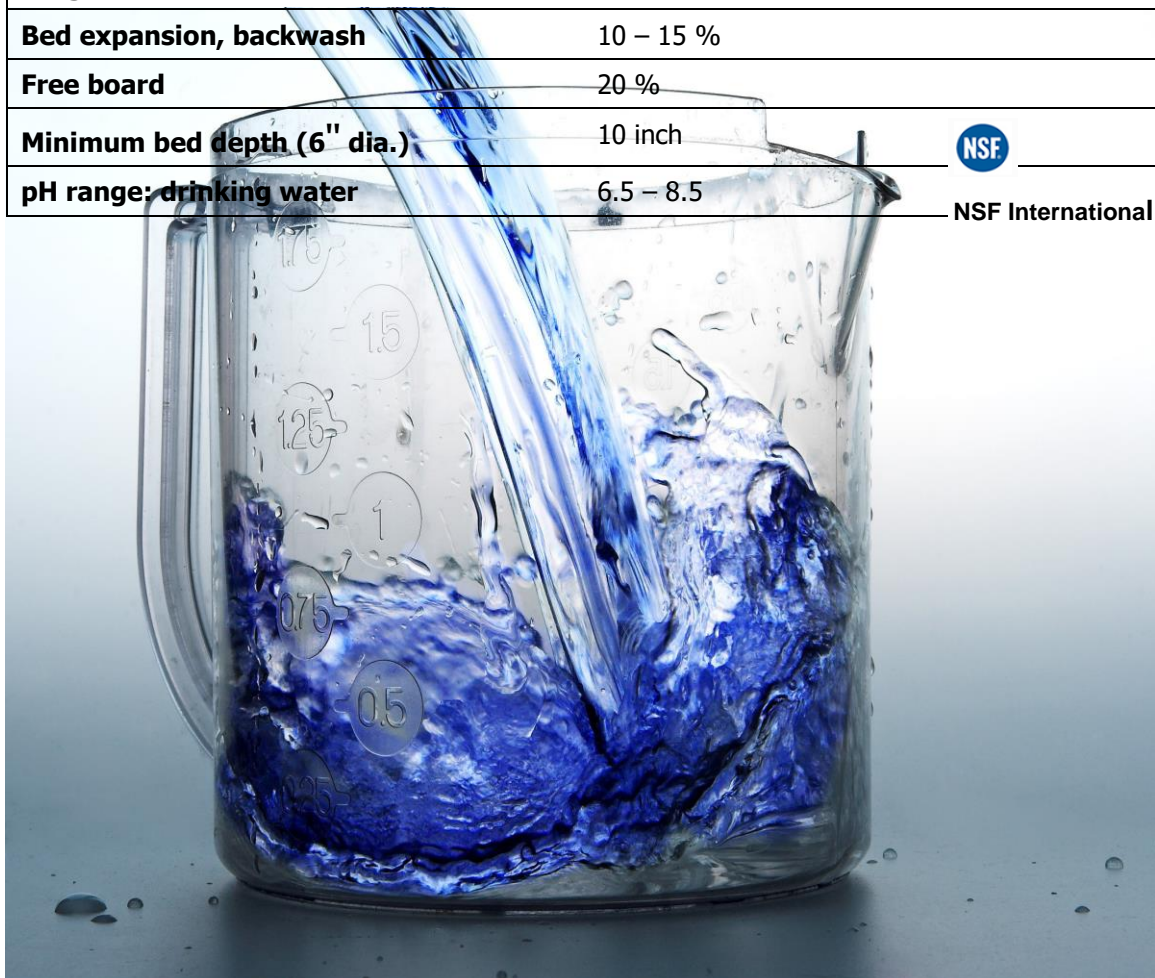

11.3.3.1. KDF 55

KDF 55 granules are designed for removing or reducing chlorine and soluble heavy metals. They are also used for controlling scale, bacteria and algae.



KDF 55 medium delivers 10 times greater filter life than GAC

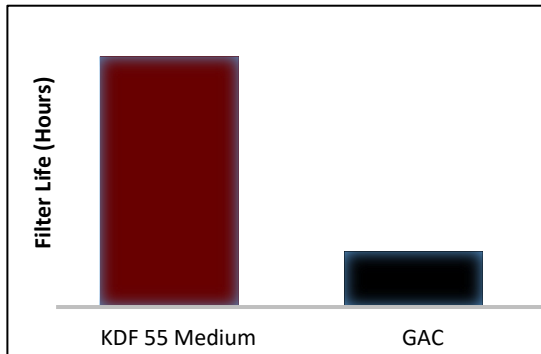

Water treatment costs with KDF 55 medium are less than half that of GAC

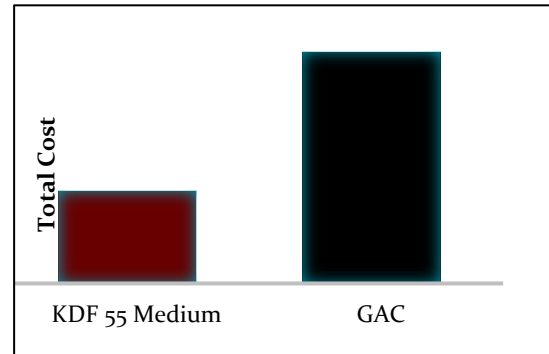

11.3.3.2. KDF 85

KDF 85 granules are used to remove or reduce iron and hydrogen sulphide from water supplies. They are also used for controlling scale, bacteria and algae.

Iron removal

Iron (Fe^{+2}) or ferrous iron in groundwater can impart objectionable taste and colour to potable water and can severely stain household fixtures. KDF process media remove iron from water, either alone or in combination with other treatment technologies used at the point of entry.

One-third as much KDF 85 medium provides three times the effective flow rate of other filter media in iron removal service.





Healthy Water. Healthy Earth. Healthy You.

11.3.4. SILIPHOS FILTER

Protects water systems in hotels, public buildings, private households and industry against scale formation and corrosion. Prevents "brown" water and clogged pipes. Save energy and money. Extends the life of water instillations.

Siliphos is a glassy polyphosphate containing silicate. The application is done by dispensers of variable size. They require no electric installation and hardly any maintenance. They only have to be refilled with spheres as consumed. Refiling is very easy.

What can SILIPHOS do for you?

Mostly natural waters cause damage in pipes, boilers and other instillations. Some contain dissolved minerals, mainly calcium and magnesium salts. These types of water are called hard.

Hard water forms scale and corrosion in water systems. This leads to disadvantages and higher energy demand. Clogged pipes may have to be replaced. Heating coils may overheat and fail.

Soft water is aggressive on metals and causes corrosion. Consequently, the tap water turns brown. Leaks and burst pipes may be the result.

SILIPHOS prevents scale and stops corrosion. It utilizes the phenomenon that very low concentrations of polyphosphates are sufficient to inhibit the disposition of scale onto metallic surfaces. Because of its phosphate and silicate content SILIPHOS also inhibits corrosion by forming a thin protective layer on the metal surface. A SILIPHOS concentration of 2 – 3 ppm is sufficient to achieve both of these effects.

SILIPHOS will also slowly remove existing scale in old pipes, even iron oxide and CaCO₃ layers to some extent.

SILIPHOS consists of 100% active substance. The use in tap water and other types of fresh water at the prescribed dosage is inoffensive. The recommended dosages are within the limits of the German drinking water regulations (TrinkwV dated 21/05/2001)

The purity of SILIPHOS and SILIPHOS II for treatment of portable water is in accordance with the existing Ec-Standard (EN 1208) as well as the requirements of the 'FAO/WHO Expert Committee on Food Additives' (7th and 19th Report). SILIPHOS II is also NSF listed since 1991 as "Drinking Water Treatment Chemicals"

SILIPHOS SPHERES

A sparingly soluble glass – like polyphosphate – silicate combination of highest purity. SILIPHOS dispensers should be refilled when 1/3 of the content is used up, normally only after approximately 3-6 months. This depends on the individual instillation.

11.3.5. 55 WATT UVC HIGHSPECTROTHERM LAMP

TUV T8 lamps are double-ended UVC (germicidal) lamps used in professional water and air disinfection units. TUV T8 lamps offer almost constant UV output over their complete lifetime, for maximum security of disinfection and high system efficacy. Moreover, they have a long and reliable lifetime, which allows maintenance to be planned for in advance.



PRODUCT DATA

GENERAL INFORMATION

Cap-Base G13 (Medium Bi-Pin Fluorescent)
Main Application Disinfection
Useful Life (Nom) 9000 h
System Description High output (HO)

LIGHT TECHNICAL

Color Designation - [Not specified]
Lumen Depreciation at 10%
useful Lifetime

OPERATING AND ELECTRICAL

Power (Rated) 54 W
(Nom)
Lamp Current (Nom) 0.77 A
Voltage (Nom) 86 V

APPROVAL AND APPLICATION

Mercury (Hg) 1.0 mg
Content (Nom)

UV

UV-C Radiation 17.5 W

PRODUCT DATA

Full product code 871150061866510
Order product name TUV 55W HO 1SL/6
EAN/UPC – Product 8711500618665
Order Code 928049504003
Numerator – Quantity
per pack 1
Numerator – Packs
per outer box 6
Material Nr. (12NC) 928049504003
Net Weight (Piece) 131.000 g

11.3.6.e-CLEAR™ HIGH OUTPUT OXYGEN & COPPER IONIZATION CHAMBER

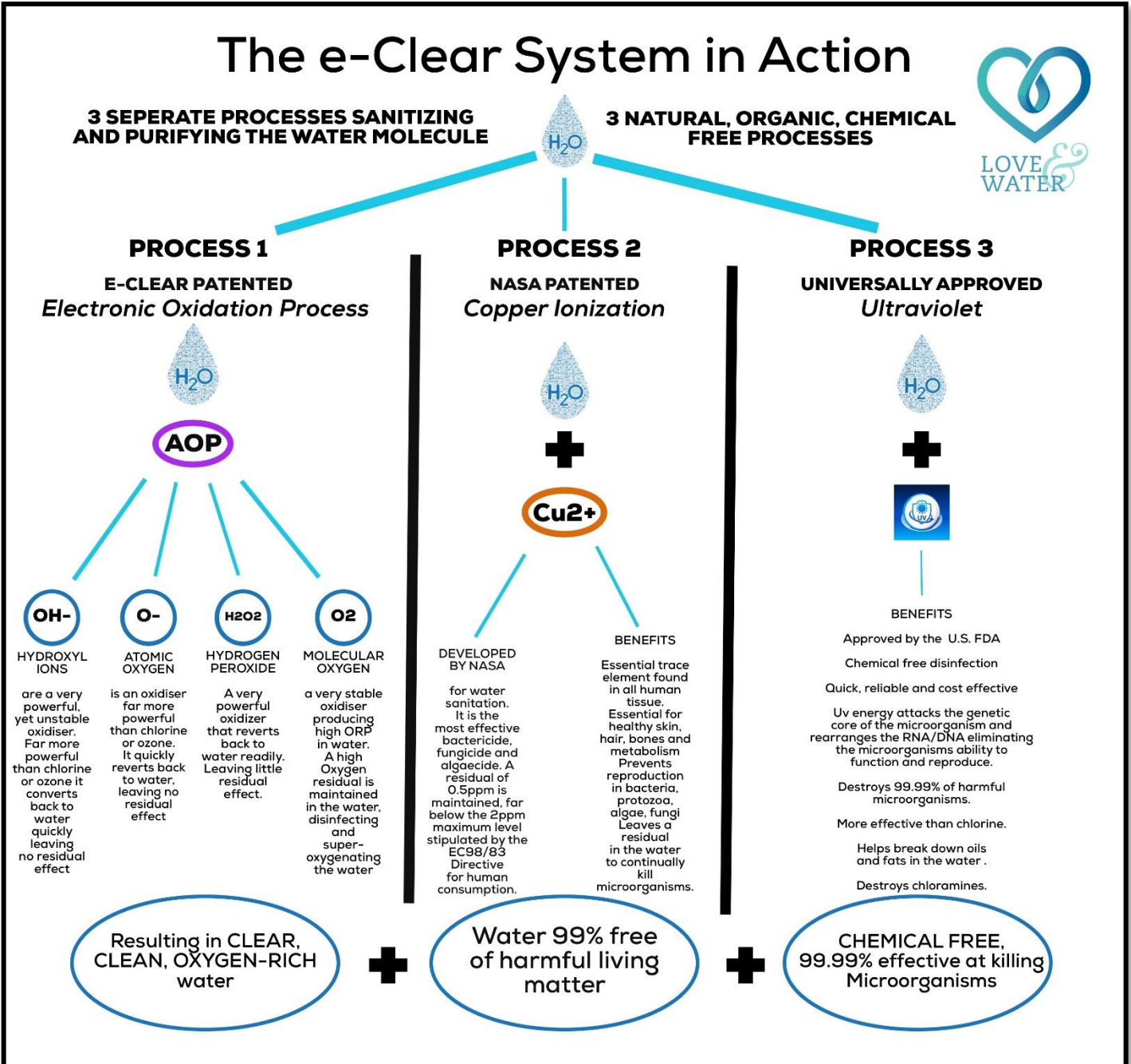

SCIENCE EXPLANTION

E-CLEAR ECO-FUSION™

RAINWATER HARVESTING KIT

11.4. E-CLEAR ECO-FUSION™ RAINWATER HARVESTING KIT



11.4.1. RATER HARVESTING AVERAGES FOR SOUTH AFRICA

*Based on 180m² home M74 12/12 pitch roof.

*1mm of rain = 1 Liter of water per square meter of roof area, minus 15% wastage.

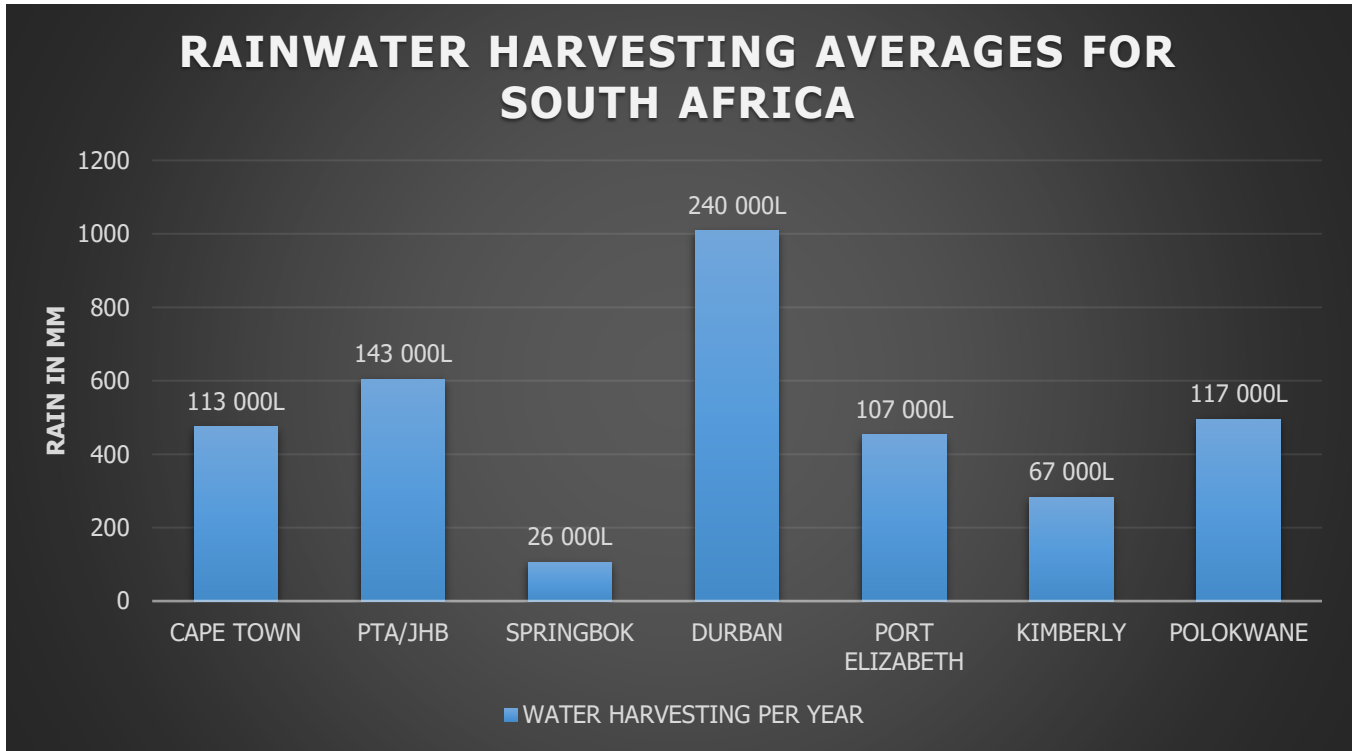

11.4.2. SPECIFICATIONS FOR RAINWATER HARESTING KIT

Please See Whole House Specifications as above Pages 45 - 52

11.4.3. 10 000L STORAGE TANK

On concrete base

11.4.4. DAVEY 600KPA 90L/M PUMP

Horizontal multistage centrifugal pump with all hydraulic parts in stainless steel. High pressure, high flow. The best household pressure system pumps on the market

11.4.5. DAVEY RAINBANK/TORRIUM SENSOR VALVE

Torrium2 controlled HM Series provides a constant flow water supply system with an all stainless steel pump unit. The Torrium2 is adaptive, eliminating cycling, provides loss of prime protection and over temperature cut out.

11.4.6. 3 BAG GLASS MEDIA FILTER

With recycled glass media, super fine grit to remove suspended matter more efficiently.

11.4.7. 0.75KW POOL PUMP

Standard economical recirculation pool pump

11.4.8. ADDITIONAL 5000L STORAGE TANK



Healthy Water. Healthy Earth. Healthy You.

11.4.9. ADDITIONAL DAVEY 0.75KW SUBMERSIBLE PUMP

11.4.10. e-CLEAR™ HIGH OUTPUT OXYGEN & COPPER IONIZATION CHAMBER

For pricing information, please contact

eClear Technologies

Office: +27 21 854 6356

Jason: +27 76 611 7803

Fax: +27 21 854 6117

jason@eclearsa.com

dave@eclearsa.com

www.eclearsa.com

www.eclear-water.com



Healthy Water. Healthy Earth. Healthy You.

